

# WERKZEUGE / ZUBEHÖR TOOLS

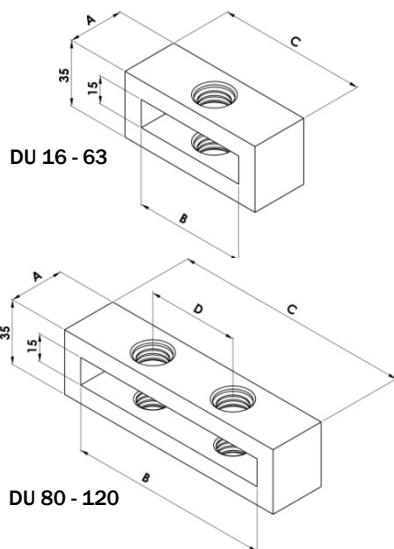

DU 16 - 63

DU 80 - 120

## BOHREINHEIT - DRILLING UNIT

Typ Item	Schiene Max. Max. Bar	A [mm]	B [mm]	C [mm]	D [mm]
DU 16	15,5x0,8x10	25	16	50	-
DU 20	20x1x10	25	20,5	50	-
DU 24	24x1x10	25	24,5	50	-
DU 32	32x1x10	30	32,5	65	-
DU 40	40x1x10	30	40,5	70	-
DU 50	50x1x10	30	50,5	80	-
DU 63	63x1x10	40	63,5	95	-
DU 80	80x1x10	40	80,5	110	40
DU 100	100x1x10	50	101	130	50
DU 120	120x1x10	50	121	150	60

Bohrer nicht enthalten (DG) / Drill guide DG not included

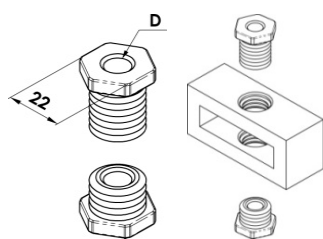

## BOHREINSÄTZE DRILL GUIDE

Typ Item	D [mm]
DG 07	7
DG 09	9
DG 11	11
DG 13	13

Max. Bohrdurchmesser  
für Gewindeinsätze (DU)  
For DU drilling unit

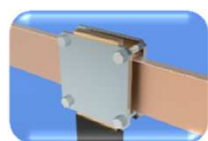

Typ Item	A x B [mm]	C x D [mm]	Ø - M	Schrauben Screws	Nm
BC 25	25x20	45x40	6,5-M6	M6X35	8 Nm
BC 22	20x20	40x40	6,5-M6	M6X35	8 Nm
BC 32	32x32	52x52	6,5-M6	M6X35	8 Nm
BC 42	40x20	60x40	6,5-M6	M6X35	8 Nm
BC 43	40x32	60x52	6,5-M6	M6X35	8 Nm
BC 44	40x40	60x60	6,5-M6	M6X35	8 Nm
BC 52	50x20	75x45	8,5-M8	M8x35	20 Nm
BC 54	50x40	75x65	8,5-M8	M8x35	20 Nm
BC 55	50x50	75x75	8,5-M8	M8x35	20 Nm
BC 63	63x32	88x57	8,5-M8	M8x35	20 Nm
BC 64	63x40	88x65	8,5-M8	M8x35	20 Nm
BC 66	63x63	88x88	8,5-M8	M8x35	20 Nm
BC 84	80x40	115x75	10,5-M10	M10x35	40 Nm
BC 88	80x80	115x115	10,5-M10	M10x35	40 Nm
BC 104	100x40	135x75	10,5-M10	M10x35	40 Nm
BC 106	100x63	135x98	10,5-M10	M10x35	40 Nm
BC 110	100x100	135x135	10,5-M10	M10x35	40 Nm

Maximale Klemmstärke: 20 mm  
Max tightening thickness with supplied screws: 20 mm

Verzinkte Schrauben Klasse 8.8 / Zinc plated class 8.8 steel screws  
Piastra in acciaio zincato / Zinc plated steel plates

1 Stk verzinkte Platte 5mm mit Löchern, 1 Stk 6 mm mit Gewinde  
One 5 mm thick plate with through holes, one 6 mm thick plate with threaded holes

Sonderausführungen auf Anfrage / Special dimensions and design upon request

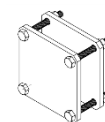
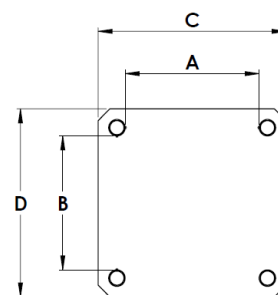
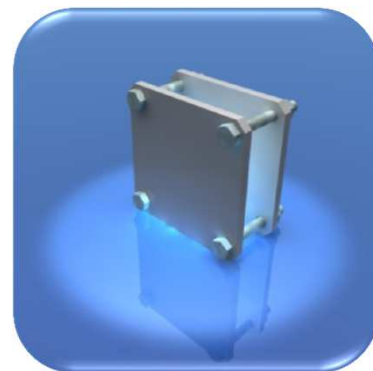

## BI-METALLPLATTEN BIMETALLIC PLATES

Gelocht Drilled	Bohrbild Holes	A [mm]	B [mm]	S [mm]	Ungebohrt Undrilled
DB 30	D1	30	30	1	UB 30
DB 40	D1	40	40	1	UB 40
DB 50	D1	50	50	1	UB 50
DB 60	D1	60	60	1	UB 60
DB 80	D4	80	80	1	UB 80
DB 100	D5	100	100	1	UB 100
DB 120	D7	120	120	1	UB 120

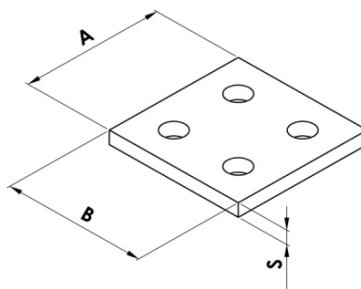

Cu-ETP / Al 99,5 Bi-Metallplatten mit Ø13mm Löchern  
Cu-ETP/Al 99,5 bimetallic plates - Ø13 mm holes

Sonderausführungen und Abmessungen auf Anfrage Special  
dimensions and design upon request

## VERZINNT KUPFERPLATTEN TIN-PLATED COPPER PLATES

Gelocht Drilled	Bohrbild Holes	A [mm]	B [mm]	S [mm]	Ungebohrt Undrilled
DP 30	D1	30	30	5	UP 30
DP 40	D1	40	40	5	UP 40
DP 50	D1	50	50	5	UP 50
DP 60	D1	60	60	5	UP 60
DP 80	D4	80	80	5	UP 80
DP 100	D5	100	100	5	UP 100
DP 120	D7	120	120	5	UP 120

Cu-ETP Platten mit Ø13mm Löchern  
Cu-ETP tin-plated plates - Ø13 mm holes

Sonderausführungen und Abmessungen auf Anfrage  
Special dimensions and design upon request