



[www.brunoconductors.it](http://www.brunoconductors.it)

# bruno

## CONDUCTORS



FLEXIBLE KUPFERBÄNDER UND KUPFERGEFLECHT  
FLEXIBLE COPPER CONDUCTORS



## DAS UNTERNEHMEN

Seit der Gründung im Jahre 1959, unterstützen wir nun seit mehr als 50 Jahren unsere Kunden mit unserer Erfahrung bei der Entwicklung von anwendungsspezifischen Lösungen. Durch die Nutzung von CAD-CAM im Produktdesign mit Kopplung zu den CNC-gesteuerten Maschinen und Anlagen optimieren wir unsere Produktionssysteme. Neben den Standard-Anwendungen sind wir spezialisiert auf die Lösung von kundenspezifischen Anforderungen.

Unser Unternehmen orientiert sich an Kundenbedürfnissen. Hohe Kundenzufriedenheit und Liefertreue sind für uns Selbstverpflichtung.



## THE COMPANY

*From 1959 we amassed more than 50 years of uninterrupted experience assisting clients from concept to finished product and using CAD-CAM design and manufacturing systems linked to CNC equipment.*

*All products are developed internally by our experienced technical team, using the latest manufacturing techniques.*

*Both standard and special products are available.*

*We have a policy of strong customer commitment with rapid deliveries for standard and custom products.*

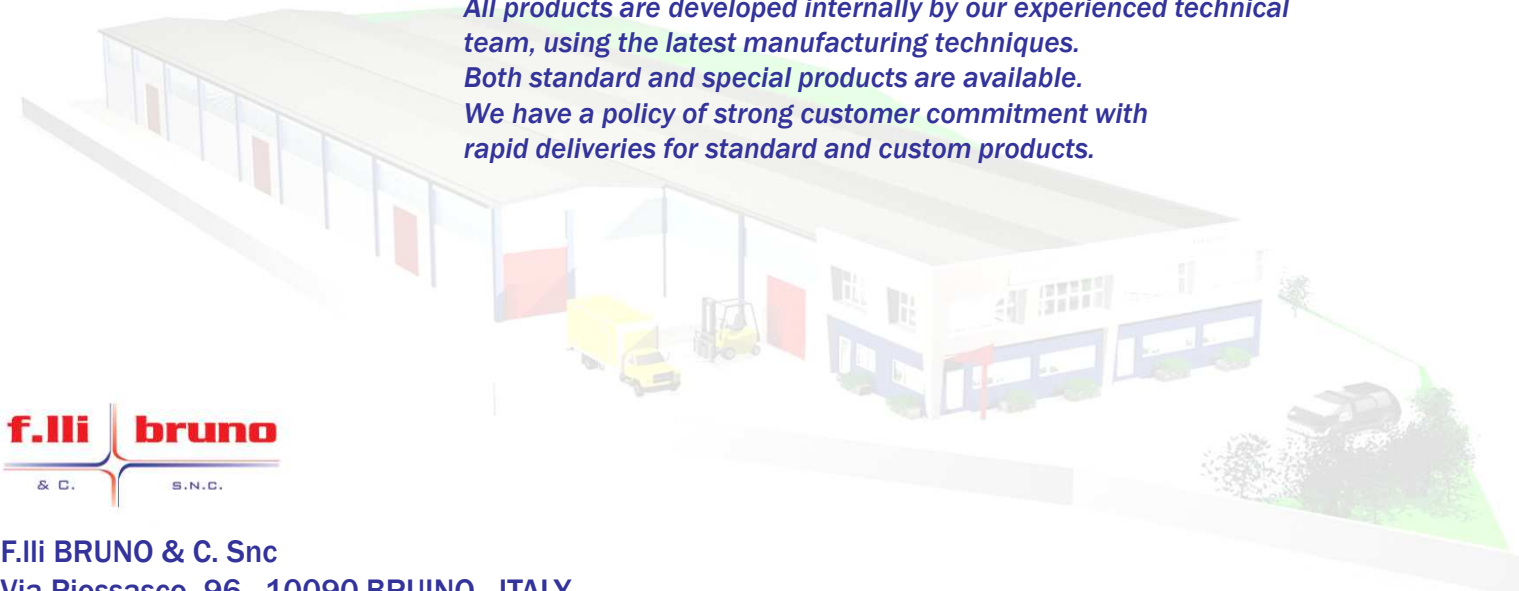

F.lli BRUNO & C. Snc  
Via Piosasco, 96 - 10090 BRUINO - ITALY  
Tel. (+39) 011 9048348  
Fax (+39) 011 9085111  
Web site: [www.brunoconductors.it](http://www.brunoconductors.it)  
E-mail: [bruno@conductors.it](mailto:bruno@conductors.it)

Bitte beachten Sie, dass es nicht erlaubt ist, unsere Fotos, Zeichnungen oder Katalogseiten ohne unsere ausdrückliche Genehmigung zu verwenden.  
*Please take notice that it is not allowed to use our photos, drawings or catalogue pages without having our explicit authorization.*



**55 ANNI YEARS**  
1959 - 2014

	<b>BÄNDER VON DER ROLLE</b> <b>BRAIDS IN ROLLS</b>	2-3
	<b>MASSE.- / ERDUNGSBÄNDER</b> <b>EARTHING BRAIDS</b>	4-5
	<b>LAST-STROMBÄNDER</b> <b>POWER CONDUCTORS</b>	6-9
	<b>ISOLIERTES KUPFERGEFLECHT - POWERFLEX</b> <b>INSULATED CONDUCTORS - POWERFLEX</b>	10
	<b>ISOLIERTES KUPFERGEFLECHT - POWERFLEX S</b> <b>INSULATED CONDUCTORS - POWERFLEX S</b>	11
	<b>ERDUNGSBÄNDER MIT KABELSCHUH</b> <b>PRESSED TERMINAL LUG CONDUCTORS</b>	12
	<b>LUFTGEKÜHLTE STROMBÄNDER</b> <b>AIR COOLED CABLES</b>	13
	<b>PRESS-VERZINNTE LAMELLIERTE STROMBÄNDER</b> <b>PRESS-TINNED LAMINATED SHUNTS</b>	14
	<b>PRESS-VERSCHWEISSTE LAMELLIERTE STROMBÄNDER</b> <b>PRESSWELDED LAMINATED SHUNTS</b>	15
	<b>GEFORMTE / BEWEGLICHE STROMBÄNDER</b> <b>MOVING LAMINATED SHUNTS</b>	16
	<b>KÜHLKÖRPER</b> <b>SHUNT COOLERS</b>	17
	<b>ISOLIERTE LAMELLIERTE STROMBÄNDER</b> <b>FLEXIBLE INSULATED BARS</b>	18-19
	<b>ZUBEHÖR</b> <b>TOOLS</b>	20
	<b>KUPFERSCHIENEN</b> <b>COPPER BUSBARS</b>	21-22
	<b>SONDERAUSFÜHRUNGEN</b> <b>SPECIAL PRODUCTS</b>	23
	<b>ISOLATOREN</b> <b>SPACING INSULATORS</b>	24
	<b>ABSTANDSSÄULEN</b> <b>SPACING COLUMNS</b>	25
	<b>SCHRUMPFSCHLÄUCHE</b> <b>HEAT SHRINK TUBING</b>	26-27

# BÄNDER VON DER ROLLE

## BRAIDS IN ROLLS

- Einzeldrahtstärke Cu-ETP UNI EN 13602 - Ø 0,20 mm  
(Ø 0,05 – 0,07 – 0,10 – 0,15 mm auf Anfrage)  
*Single wire Cu-ETP UNI EN 13602 - Ø 0,20 mm  
(Ø 0,05 – 0,07 – 0,10 – 0,15 mm upon request)*
- Andere Materialien, Ausführung auf Anfrage  
*Special braid materials and structure upon request*
- Andere Dimensionen und Längen auf Anfrage  
*Special dimensions and lengths upon request*

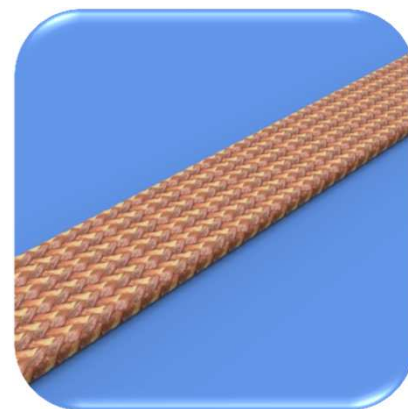
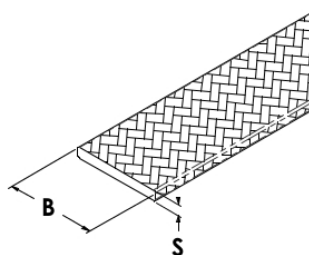

## FLACHE SCHLAUCHBÄNDER

### FLAT TUBULAR BRAID

Kupfer blank <i>Bare Copper</i>	Kupfer verzinkt <i>Tin-Plated Copper</i>	Querschnitt <i>Cross-Sect.</i> [mm <sup>2</sup> ]	Einzeldraht <i>Single wire</i> Ø [mm]	B [mm]	S [mm]	L [m]	Strombelastung <i>Current load</i> ΔT 30 °C
TR 6/020-10/25	TS 6/020-10/25	6	0,20	10	1,5	25	55 A
TR 6/020-10/100	TS 6/020-10/100	6	0,20	10	1,5	100	55 A
TR 10/020-10/25	TS 10/020-10/25	10	0,20	10	2	25	80 A
TR 10/020-10/100	TS 10/020-10/100	10	0,20	10	2	100	80 A
TR 10/020-15/25	TS 10/020-15/25	10	0,20	15	2	25	80 A
TR 10/020-15/100	TS 10/020-15/100	10	0,20	15	2	100	80 A
TR 16/020-15/25	TS 16/020-15/25	16	0,20	15	2,5	25	120 A
TR 16/020-15/100	TS 16/020-15/100	16	0,20	15	2,5	100	120 A
TR 25/020-20/25	TS 25/020-20/25	25	0,20	20	3,2	25	150 A
TR 25/020-20/100	TS 25/020-20/100	25	0,20	20	3,2	100	150 A
TR 35/020-20/25	TS 35/020-20/25	35	0,20	20	3,4	25	195 A
TR 35/020-20/100	TS 35/020-20/100	35	0,20	20	3,4	100	195 A
TR 50/020-28/25	TS 50/020-28/25	50	0,20	28	3,6	25	250 A
TR 50/020-28/50	TS 50/020-28/50	50	0,20	28	3,6	50	250 A
TR 75/020-28/25	TS 75/020-28/25	75	0,20	28	5	25	300 A
TR 75/020-28/50	TS 75/020-28/50	75	0,20	28	5	50	300 A
TR 100/020-32/10	TS 100/020-32/10	100	0,20	32	6	10	370 A
TR 100/020-32/25	TS 100/020-32/25	100	0,20	32	6	25	370 A
TR 120/020-35/10	TS 120/020-35/10	120	0,20	35	7	10	410 A
TR 120/020-35/25	TS 120/020-35/25	120	0,20	35	7	25	410 A
TR 150/020-38/10	TS 150/020-38/10	150	0,20	38	8	10	470 A
TR 150/020-38/25	TS 150/020-38/25	150	0,20	38	8	25	470 A
TR 200/020-40/10	TS 200/020-40/10	200	0,20	40	10	10	560 A
TR 200/020-40/25	TS 200/020-40/25	200	0,20	40	10	25	560 A
TR 250/020-40/10	TS 250/020-40/10	250	0,20	40	12,5	10	640 A
TR 250/020-40/25	TS 250/020-40/25	250	0,20	40	12,5	25	640 A
TR 300/020-50/10	TS 300/020-50/10	300	0,20	50	12	10	740 A
TR 300/020-50/25	TS 300/020-50/25	300	0,20	50	12	25	740 A

Strombelastungen sind circa Angaben - Verwies auf Umgebungstemperatur 35° C (siehe Seite 28)

*Conductors current loads are approximated and related to the ambient temperature of 35 °C (please see page 28)*

### RUNDLEITER

#### ROUND BRAID

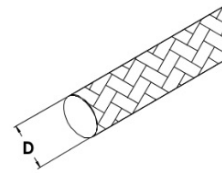

Kupfer blank Bare Copper	Kupfer verzinkt Tin-Plated Copper	Querschnitt Cross-Sect. [mm <sup>2</sup> ]	Einzelader Single wire Ø [mm]	D [mm]	L [m]	Strombelastung Current load ΔT 30 °C
RR 6/020-4/25	RS 6/020-4/25	6	0,20	4	25	50 A
RR 6/020-4/100	RS 6/020-4/100	6	0,20	4	100	50 A
RR 10/020-5/25	RS 10/020-5/25	10	0,20	5	25	75 A
RR 10/020-5/100	RS 10/020-5/100	10	0,20	5	100	75 A
RR 16/020-6/25	RS 16/020-6/25	16	0,20	6	25	110 A
RR 16/020-6/100	RS 16/020-6/100	16	0,20	6	100	110 A
RR 25/020-8/25	RS 25/020-8/25	25	0,20	8	25	140 A
RR 25/020-8/100	RS 25/020-8/100	25	0,20	8	100	140 A
RR 35/020-9/25	RS 35/020-9/25	35	0,20	9	25	185 A
RR 35/020-9/100	RS 35/020-9/100	35	0,20	9	100	185 A
RR 50/020-11/25	RS 50/020-11/25	50	0,20	11	25	240 A
RR 50/020-11/50	RS 50/020-11/50	50	0,20	11	50	240 A
RR 75/020-13/25	RS 75/020-13/25	75	0,20	13,5	25	285 A
RR 75/020-13/50	RS 75/020-13/50	75	0,20	13,5	50	285 A
RR 100/020-16/10	RS 100/020-16/10	100	0,20	16	10	350 A
RR 100/020-16/25	RS 100/020-16/25	100	0,20	16	25	350 A
RR 120/020-18/10	RS 120/020-18/10	120	0,20	17,5	10	390 A
RR 120/020-18/25	RS 120/020-18/25	120	0,20	17,5	25	390 A
RR 150/020-20/10	RS 150/020-20/10	150	0,20	20	10	450 A
RR 150/020-20/25	RS 150/020-20/25	150	0,20	20	25	450 A

### VERSEILTE LEITER

#### TWISTED CABLE

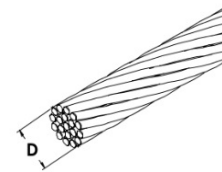

Kupfer blank Bare Copper	Kupfer verzinkt Tin-Plated Copper	Querschnitt Cross-Sect. [mm <sup>2</sup> ]	Einzelader Single wire Ø [mm]	D [mm]	L [m]	Strombelastung Current load ΔT 30 °C
CR 6/020-4/25	CS 6/020-4/25	6	0,20	4	25	50 A
CR 6/020-4/100	CS 6/020-4/100	6	0,20	4	100	50 A
CR 10/020-5/25	CS 10/020-5/25	10	0,20	5	25	75 A
CR 10/020-5/100	CS 10/020-5/100	10	0,20	5	100	75 A
CR 16/020-6/25	CS 16/020-6/25	16	0,20	6	25	110 A
CR 16/020-6/100	CS 16/020-6/100	16	0,20	6	100	110 A
CR 25/020-8/25	CS 25/020-8/25	25	0,20	8	25	140 A
CR 25/020-8/100	CS 25/020-8/100	25	0,20	8	100	140 A
CR 35/020-9/25	CS 35/020-9/25	35	0,20	9	25	185 A
CR 35/020-9/100	CS 35/020-9/100	35	0,20	9	100	185 A
CR 50/020-11/25	CS 50/020-11/25	50	0,20	11	25	240 A
CR 50/020-11/50	CS 50/020-11/50	50	0,20	11	50	240 A
CR 75/020-13/25	CS 75/020-13/25	75	0,20	13,5	25	285 A
CR 75/020-13/50	CS 75/020-13/50	75	0,20	13,5	50	285 A
CR 100/020-16/10	CS 100/020-16/10	100	0,20	16	10	350 A
CR 100/020-16/25	CS 100/020-16/25	100	0,20	16	25	350 A
CR 120/020-18/10	CS 120/020-18/10	120	0,20	17,5	10	390 A
CR 120/020-18/25	CS 120/020-18/25	120	0,20	17,5	25	390 A
CR 150/020-20/10	CS 150/020-20/10	150	0,20	20	10	450 A
CR 150/020-20/25	CS 150/020-20/25	150	0,20	20	25	450 A

Strombelastungen sind circa Angaben - Verwies auf Umgebungstemperatur 35 ° C (siehe Seite 28)

Conductors current loads are approximated and related to the ambient temperature of 35 °C (please see page 28)

# MASSE.- / ERDUNGSBÄNDER

## EARTHING BRAIDS



FR

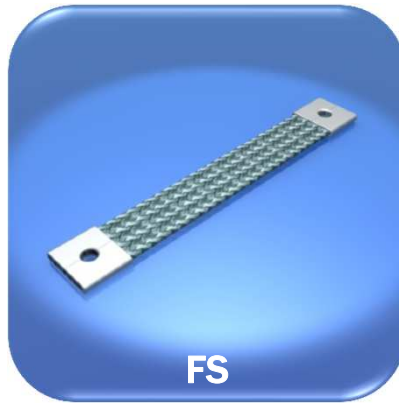

FS



FR/S

- Enden in Cu-ETP UNI EN 1652 verpresst  
*Cu-ETP UNI EN 1652 strip terminals*
- Einzeldraht Cu-ETP UNI EN 13602  
*Single wire Cu-ETP UNI EN 13602*
- Spezialisolation auf Anfrage  
*Special insulation upon request*

- Pressverschweisst auf Anfrage (WR/WS)  
*Presswelded terminals upon request (WR/WS)*
- Heiß-Tauchverzinnte Kontaktflächen auf Anfrage  
*Hot tin dipped terminals upon request*
- Aluminium auf Anfrage  
*In Aluminium upon request*

### SONDER.- / KUNDENAUSFÜHRUNGEN

#### CUSTOM-MADE SOLUTIONS

Im Auftragsfall die Maße "L" und "D" einfügen  
*Please insert "L" and "D" dimensions in your orders*

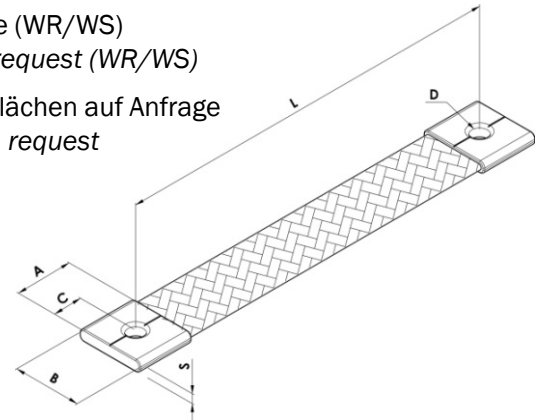

Kupfer blank <i>Bare Copper</i>	Kupfer verzinnt <i>Tin-Plated Copper</i>	Endhülsen verzinnt <i>Tin-Plated Terminals</i>	Querschnitt <i>Cross-Sect.</i> [mm <sup>2</sup> ]	Einzeldraht <i>Single wire</i> Ø [mm]	A [mm]	B [mm]	C [mm]	D [mm]	S [mm]	Strombelastung <i>Current load</i> ΔT 30 °C
FR 2,5-7/L-D	FS 2,5-7/L-D	FR/S 2,5-7/L-D	2,5	0,20	8	7	4	3,2	1,5	30 A
FR 2,5-7/L-D	FS 2,5-7/L-D	FR/S 2,5-7/L-D	2,5	0,20	11	7	5	4,3	1,5	30 A
FR 4-9/L-D	FS 4-9/L-D	FR/S 4-9/L-D	4	0,20	11	9	5	4,3-5,3	1,7	45 A
FR 6-9/L-D	FS 6-9/L-D	FR/S 6-9/L-D	6	0,20	11	9	5	4,3-5,3	2	55 A
FR 6-11/L-D	FS 6-11/L-D	FR/S 6-11/L-D	6	0,20	13	11	5	5,3-7	1,5	60 A
FR 10-11/L-D	FS 10-11/L-D	FR/S 10-11/L-D	10	0,20	13	11	5	5,3-7	2,2	80 A
FR 10-14/L-D	FS 10-14/L-D	FR/S 10-14/L-D	10	0,20	13	14	6	5,3-7	2,1	90 A
FR 10-17/L-D	FS 10-17/L-D	FR/S 10-17/L-D	10	0,20	23	17	10	7-9-11-13	2	90 A
FR 16-14/L-D	FS 16-14/L-D	FR/S 16-14/L-D	16	0,20	13	14	6	5,3-7	2,6	120 A
FR 16-17/L-D	FS 16-17/L-D	FR/S 16-17/L-D	16	0,20	23	17	10	7-9-11-13	2,5	120 A
FR 25-23/L-D	FS 25-23/L-D	FR/S 25-23/L-D	25	0,20	23	23	10	7-9-11-13	3,2	150 A
FR 35-23/L-D	FS 35-23/L-D	FR/S 35-23/L-D	35	0,20	23	23	10	7-9-11-13	3,4	195 A
FR 50-23/L-D	FS 50-23/L-D	FR/S 50-23/L-D	50	0,20	23	23	10	7-9-11-13	4,5	230 A
FR 50-30/L-D	FS 50-30/L-D	FR/S 50-30/L-D	50	0,20	30	30	15	9-11-13-15	4	250 A
FR 75-30/L-D	FS 75-30/L-D	FR/S 75-30/L-D	75	0,20	30	30	15	9-11-13-15	5	300 A
FR 100-35/L-D	FS 100-35/L-D	FR/S 100-35/L-D	100	0,20	35	35	15	9-11-13-15	6	370 A
FR 150-35/L-D	FS 150-35/L-D	FR/S 150-35/L-D	150	0,20	35	35	15	9-11-13-15	8	460 A
FR 200-35/L-D	FS 200-35/L-D	FR/S 200-35/L-D	200	0,20	35	35	15	9-11-13-15	10	540 A

Spezielle Abmessungen und Ausführungen auf Anfrage / *Special dimensions and design upon request*

Strombelastungen sind circa Angaben (siehe Seite 28) / *Conductors current loads are approximated (please see page 28)*

Verwies auf Umgebungstemperatur 35° C / *Referred to Ambient Temperature 35 °C*

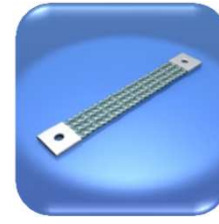
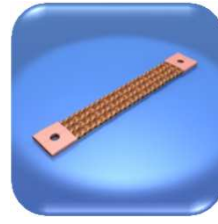
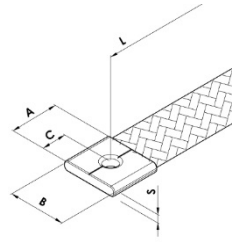

## DIMENSIONI STANDARD STANDARD DIMENSIONS

Kupfer blank <i>Bare Copper</i>	Kupfer verzinkt <i>Tin-Plated Copper</i>	Endhülsen verzinkt <i>Tin-Plated Terminals</i>	Querschnitt Cross-Sect. [mm <sup>2</sup> ]	Einzelader Single wire Ø [mm]	A [mm]	B [mm]	C [mm]	D [mm]	S [mm]	L [mm]	Strombelastung Current load ΔT 30 °C
FR 6-11/75-7	FS 6-11/75-7	FR/S 6-11/75-7	6	0,20	13	11	5	7	1,5	75	60 A
FR 6-11/100-7	FS 6-11/100-7	FR/S 6-11/100-7	6	0,20	13	11	5	7	1,5	100	60 A
FR 6-11/150-7	FS 6-11/150-7	FR/S 6-11/150-7	6	0,20	13	11	5	7	1,5	150	60 A
FR 10-17/100-9	FS 10-17/100-9	FR/S 10-17/100-9	10	0,20	23	17	10	9	2	100	90 A
FR 10-17/150-9	FS 10-17/150-9	FR/S 10-17/150-9	10	0,20	23	17	10	9	2	150	90 A
FR 10-17/200-9	FS 10-17/200-9	FR/S 10-17/200-9	10	0,20	23	17	10	9	2	200	90 A
FR 10-17/250-9	FS 10-17/250-9	FR/S 10-17/250-9	10	0,20	23	17	10	9	2	250	90 A
FR 10-17/300-9	FS 10-17/300-9	FR/S 10-17/300-9	10	0,20	23	17	10	9	2	300	90 A
FR 16-17/150-9	FS 16-17/150-9	FR/S 16-17/150-9	16	0,20	23	17	10	9	2,5	150	120 A
FR 16-17/200-9	FS 16-17/200-9	FR/S 16-17/200-9	16	0,20	23	17	10	9	2,5	200	120 A
FR 16-17/250-9	FS 16-17/250-9	FR/S 16-17/250-9	16	0,20	23	17	10	9	2,5	250	120 A
FR 16-17/300-9	FS 16-17/300-9	FR/S 16-17/300-9	16	0,20	23	17	10	9	2,5	300	120 A
FR 16-17/350-9	FS 16-17/350-9	FR/S 16-17/350-9	16	0,20	23	17	10	9	2,5	350	120 A
FR 25-23/150-9	FS 25-23/150-9	FR/S 25-23/150-9	25	0,20	23	23	10	9	3,2	150	150 A
FR 25-23/200-9	FS 25-23/200-9	FR/S 25-23/200-9	25	0,20	23	23	10	9	3,2	200	150 A
FR 25-23/250-9	FS 25-23/250-9	FR/S 25-23/250-9	25	0,20	23	23	10	9	3,2	250	150 A
FR 25-23/300-9	FS 25-23/300-9	FR/S 25-23/300-9	25	0,20	23	23	10	9	3,2	300	150 A
FR 25-23/350-9	FS 25-23/350-9	FR/S 25-23/350-9	25	0,20	23	23	10	9	3,2	350	150 A
FR 35-23/150-9	FS 35-23/150-9	FR/S 35-23/150-9	35	0,20	23	23	10	9	3,4	150	195 A
FR 35-23/200-9	FS 35-23/200-9	FR/S 35-23/200-9	35	0,20	23	23	10	9	3,4	200	195 A
FR 35-23/250-9	FS 35-23/250-9	FR/S 35-23/250-9	35	0,20	23	23	10	9	3,4	250	195 A
FR 35-23/300-9	FS 35-23/300-9	FR/S 35-23/300-9	35	0,20	23	23	10	9	3,4	300	195 A
FR 35-23/350-9	FS 35-23/350-9	FR/S 35-23/350-9	35	0,20	23	23	10	9	3,4	350	195 A
FR 50-30/150-11	FS 50-30/150-11	FR/S 50-30/150-11	50	0,20	30	30	15	11	4	150	250 A
FR 50-30/200-11	FS 50-30/200-11	FR/S 50-30/200-11	50	0,20	30	30	15	11	4	200	250 A
FR 50-30/250-11	FS 50-30/250-11	FR/S 50-30/250-11	50	0,20	30	30	15	11	4	250	250 A
FR 50-30/300-11	FS 50-30/300-11	FR/S 50-30/300-11	50	0,20	30	30	15	11	4	300	250 A
FR 50-30/350-11	FS 50-30/350-11	FR/S 50-30/350-11	50	0,20	30	30	15	11	4	350	250 A
FR 75-30/150-11	FS 75-30/150-11	FR/S 75-30/150-11	75	0,20	30	30	15	11	5	150	300 A
FR 75-30/200-11	FS 75-30/200-11	FR/S 75-30/200-11	75	0,20	30	30	15	11	5	200	300 A
FR 75-30/250-11	FS 75-30/250-11	FR/S 75-30/250-11	75	0,20	30	30	15	11	5	250	300 A
FR 75-30/300-11	FS 75-30/300-11	FR/S 75-30/300-11	75	0,20	30	30	15	11	5	300	300 A
FR 75-30/350-11	FS 75-30/350-11	FR/S 75-30/350-11	75	0,20	30	30	15	11	5	350	300 A
FR 100-35/150-13	FS 100-35/150-13	FR/S 100-35/150-13	100	0,20	35	35	15	13	6	150	370 A
FR 100-35/200-13	FS 100-35/200-13	FR/S 100-35/200-13	100	0,20	35	35	15	13	6	200	370 A
FR 100-35/250-13	FS 100-35/250-13	FR/S 100-35/250-13	100	0,20	35	35	15	13	6	250	370 A
FR 100-35/300-13	FS 100-35/300-13	FR/S 100-35/300-13	100	0,20	35	35	15	13	6	300	370 A
FR 100-35/350-13	FS 100-35/350-13	FR/S 100-35/350-13	100	0,20	35	35	15	13	6	350	370 A
FR 150-35/150-13	FS 150-35/150-13	FR/S 150-35/150-13	150	0,20	35	35	15	13	8	150	460 A
FR 150-35/200-13	FS 150-35/200-13	FR/S 150-35/200-13	150	0,20	35	35	15	13	8	200	460 A
FR 150-35/250-13	FS 150-35/250-13	FR/S 150-35/250-13	150	0,20	35	35	15	13	8	250	460 A
FR 150-35/300-13	FS 150-35/300-13	FR/S 150-35/300-13	150	0,20	35	35	15	13	8	300	460 A
FR 150-35/350-13	FS 150-35/350-13	FR/S 150-35/350-13	150	0,20	35	35	15	13	8	350	460 A
FR 200-35/150-13	FS 200-35/150-13	FR/S 200-35/150-13	200	0,20	35	35	15	13	10	150	540 A
FR 200-35/200-13	FS 200-35/200-13	FR/S 200-35/200-13	200	0,20	35	35	15	13	10	200	540 A
FR 200-35/250-13	FS 200-35/250-13	FR/S 200-35/250-13	200	0,20	35	35	15	13	10	250	540 A
FR 200-35/300-13	FS 200-35/300-13	FR/S 200-35/300-13	200	0,20	35	35	15	13	10	300	540 A
FR 200-35/350-13	FS 200-35/350-13	FR/S 200-35/350-13	200	0,20	35	35	15	13	10	350	540 A

# LAST - STROMBÄNDER POWER CONDUCTORS



- Verzinnte Endhülsen Cu-DHP UNI EN 12499  
*Cu-DHP UNI EN 12499 Tin-plated tubular terminals*
- Blanke, versilberte und vernickelte Endhülsen auf Anfrage  
*Bare, silver or nickel plated terminals upon request*
- Einzeldrahtstärke Cu-ETP UNI EN 13602 - Ø 0,20 mm  
(Ø 0,05 - 0,07 - 0,10 - 0,15 mm auf Anfrage)  
*Single wire Cu-ETP UNI EN 13602 - Ø 0,20 mm  
(Ø 0,05 - 0,07 - 0,10 - 0,15 mm upon request)*
- Spezielle Werkstoffe und Ausbildung des Geflechts auf Anfrage  
*Special braid materials and structure upon request*
- Sonderausführungen auf Anfrage  
*Special dimensions and design upon request*
- Aluminium auf Anfrage  
*In Aluminium upon request*

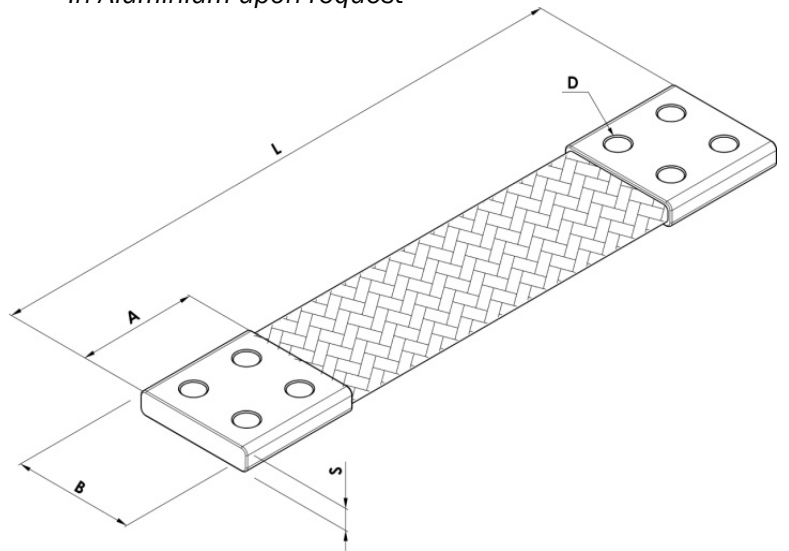

- Abmessungen variable "B":

*Available standard dimensions for "B":*

8 - 10 - 12 - 15 - 17 - 20 - 22 - 25 - 30 - 32 - 35 - 38 - 40 - 43 - 45 - 47 - 48 - 50 - 55 - 56 - 58 - 60 - 63 - 70 - 80 - 90 - 97 - 100 - 120 - 140 - 145 - 150 - 160 - 200 [mm]      Sonderausführungen auf Anfrage / *Special dimensions realized upon request*

## BOHRBILDER DRILLING PATTERNS

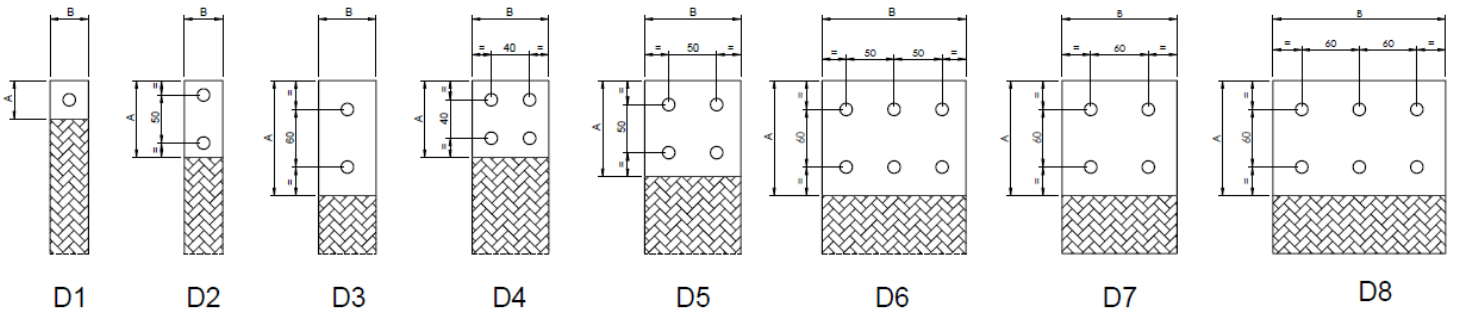

- Sonderausführung des Lochbildes und Lochgröße gemäss DIN 43673 sind verfügbar  
*Custom-made drilling patterns or according to DIN 43673 are also available*



# LAST - STROMBÄNDER

## POWER CONDUCTORS

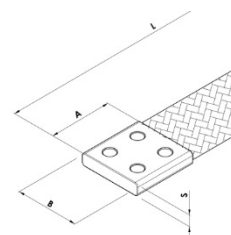

Kupfer blank Bare Copper	Kupfer verzinkt Tin-Plated Copper	Querschnitt Cross-Sect. [mm <sup>2</sup> ]	A [mm]	B [mm]	S [mm]	L [mm]	D [mm]	Bohrbild Drilling	Strombelastung Current load		
									ΔT 30 °C	ΔT 50 °C	ΔT 70 °C
FRS 10/020-200/10	FSS 10/020-200/10	10	10	10	3,5	200	5	D1	80 A	110 A	140 A
FRS 10/020-200/12	FSS 10/020-200/12	10	12	12	3,2	200	6	D1	80 A	110 A	140 A
FRS 16/020-200/15	FSS 16/020-200/15	16	15	15	3,5	200	7	D1	110 A	160 A	190 A
FRS 16/020-200/17	FSS 16/020-200/17	16	17	17	3,3	200	9	D1	120 A	160 A	200 A
FRS 25/020-200/20	FSS 25/020-200/20	25	20	20	3,7	200	9	D1	150 A	210 A	260 A
FRS 25/020-200/22	FSS 25/020-200/22	25	22	22	3,5	200	9	D1	160 A	220 A	270 A
FRS 25/020-200/25	FSS 25/020-200/25	25	25	25	3,3	200	11	D1	160 A	220 A	280 A
FRS 35/020-200/22	FSS 35/020-200/22	35	22	22	4,1	200	9	D1	190 A	260 A	320 A
FRS 35/020-200/25	FSS 35/020-200/25	35	25	25	3,8	200	11	D1	190 A	270 A	330 A
FRS 50/020-200/25	FSS 50/020-200/25	50	25	25	4,6	200	11	D1	230 A	320 A	400 A
FRS 50/020-200/30	FSS 50/020-200/30	50	30	30	4,2	200	11	D1	250 A	340 A	420 A
FRS 50/020-250/35	FSS 50/020-250/35	50	35	35	3,8	250	13	D1	260 A	350 A	430 A
FRS 75/020-200/30	FSS 75/020-200/30	75	30	30	5,2	200	13	D1	300 A	420 A	510 A
FRS 75/020-250/35	FSS 75/020-250/35	75	35	35	4,8	250	13	D1	320 A	440 A	540 A
FRS 100/020-200/30	FSS 100/020-200/30	100	30	30	6	200	13	D1	350 A	490 A	600 A
FRS 100/020-250/35	FSS 100/020-250/35	100	35	35	5,6	250	13	D1	370 A	510 A	620 A
FRS 100/020-250/40	FSS 100/020-250/40	100	40	40	5,2	250	13	D1	380 A	530 A	650 A
FRS 120/020-200/30	FSS 120/020-200/30	120	30	30	7	200	13	D1	390 A	540 A	660 A
FRS 120/020-250/35	FSS 120/020-250/35	120	35	35	6,5	250	13	D1	410 A	560 A	690 A
FRS 120/020-250/40	FSS 120/020-250/40	120	40	40	6	250	13	D1	420 A	580 A	710 A
FRS 150/020-200/30	FSS 150/020-200/30	150	30	30	8	200	13	D1	440 A	610 A	750 A
FRS 150/020-250/35	FSS 150/020-250/35	150	35	35	7,5	250	13	D1	460 A	630 A	780 A
FRS 150/020-250/40	FSS 150/020-250/40	150	40	40	6,8	250	13	D1	470 A	650 A	800 A
FRS 150/020-250/45	FSS 150/020-250/45	150	45	45	6,2	250	13	D1	490 A	670 A	830 A
FRS 200/020-300/40	FSS 200/020-300/40	200	40	40	8,3	300	13	D1	550 A	760 A	940 A
FRS 200/020-300/45	FSS 200/020-300/45	200	45	45	7,6	300	13	D1	570 A	780 A	960 A
FRS 200/020-300/50	FSS 200/020-300/50	200	50	50	7	300	13	D1	590 A	810 A	990 A
FRS 200/020-350/40	FSS 200/020-350/40	200	100	40	8,3	350	13	D2	550 A	760 A	940 A
FRS 200/020-350/50	FSS 200/020-350/50	200	100	50	7	350	13	D2	590 A	780 A	990 A
FRS 250/020-300/40	FSS 250/020-300/40	250	40	40	10	300	13	D1	630 A	860 A	1060 A
FRS 250/020-300/45	FSS 250/020-300/45	250	45	45	9	300	13	D1	640 A	890 A	1090 A
FRS 250/020-300/50	FSS 250/020-300/50	250	50	50	8,3	300	13	D1	660 A	910 A	1120 A
FRS 250/020-350/40	FSS 250/020-350/40	250	100	40	10	350	13	D2	630 A	860 A	1060 A
FRS 250/020-350/50	FSS 250/020-350/50	250	100	50	8,3	350	13	D2	660 A	910 A	1120 A
FRS 300/020-300/45	FSS 300/020-300/45	300	45	45	10,6	300	13	D1	710 A	980 A	1200 A
FRS 300/020-300/50	FSS 300/020-300/50	300	50	50	9,5	300	13	D1	730 A	1000 A	1230 A
FRS 300/020-300/60	FSS 300/020-300/60	300	60	60	8,5	300	13	D1	770 A	1050 A	1300 A
FRS 300/020-400/45	FSS 300/020-400/45	300	80	45	10,6	400	13	D2	710 A	980 A	1200 A
FRS 300/020-400/50	FSS 300/020-400/50	300	100	50	9,5	400	13	D2	730 A	1000 A	1230 A
FRS 300/020-400/60	FSS 300/020-400/60	300	120	60	8,5	400	13	D2	770 A	1050 A	1300 A
FRS 300/020-400/70	FSS 300/020-400/70	300	120	70	8,3	400	13	D2	800 A	1110 A	1360 A
FRS 400/020-300/50	FSS 400/020-300/50	400	50	50	12	300	13	D1	850 A	1180 A	1450 A
FRS 400/020-400/40	FSS 400/020-400/40	400	80	40	15	400	13	D2	820 A	1130 A	1390 A
FRS 400/020-400/50	FSS 400/020-400/50	400	100	50	12	400	13	D2	850 A	1180 A	1450 A
FRS 400/020-400/60	FSS 400/020-400/60	400	120	60	10,5	400	13	D3	890 A	1230 A	1510 A
FRS 400/020-400/80	FSS 400/020-400/80	400	80	80	9,5	400	13	D4	970 A	1340 A	1650 A
FRS 400/020-400/100	FSS 400/020-400/100	400	100	100	8	400	13	D5	1040 A	1430 A	1760 A
FRS 400/020-400/120	FSS 400/020-400/120	400	120	120	7	400	13	D7	1100 A	1520 A	1870 A
FRS 500/020-400/50	FSS 500/020-400/50	500	100	50	14,5	400	13	D2	970 A	1330 A	1640 A
FRS 500/020-400/60	FSS 500/020-400/60	500	120	60	12,5	400	13	D3	1010 A	1390 A	1710 A
FRS 500/020-400/80	FSS 500/020-400/80	500	80	80	11	400	13	D4	1090 A	1510 A	1850 A
FRS 500/020-400/90	FSS 500/020-400/90	500	120	90	10	400	13	D4	1130 A	1560 A	1920 A
FRS 500/020-400/100	FSS 500/020-400/100	500	100	100	9,2	400	13	D5	1170 A	1610 A	1980 A
FRS 500/020-450/120	FSS 500/020-450/120	500	120	120	8,5	450	13	D7	1240 A	1720 A	2100 A
FRS 500/020-450/140	FSS 500/020-450/140	500	120	140	8,5	450	13	D7	1310 A	1800 A	2210 A
FRS 500/020-450/150	FSS 500/020-450/150	500	120	150	7	450	13	D6	1330 A	1840 A	2260 A
FRS 500/020-450/160	FSS 500/020-450/160	500	120	160	9	450	13	D6	1370 A	1890 A	2320 A
FRS 500/020-500/200	FSS 500/020-500/200	500	120	200	9	500	13	D8	1480 A	2040 A	2510 A

Spezielle Bohrungen , Abmessungen und Ausführungen auf Anfrage / *Special drillings, dimensions and design upon request*

Strombelastungen sind circa Angaben (siehe Seite 28) / *Conductors current loads are approximated (please see page 28)*

Verwies auf Umgebungstemperatur 35° C / *Referred to Ambient Temperature 35 °C*

# LAST - STROMBÄNDER POWER CONDUCTORS

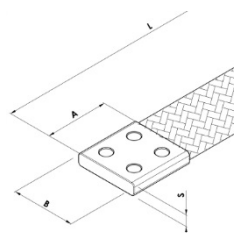

Kupfer blank <i>Bare Copper</i>	Kupfer verzinkt <i>Tin-Plated Copper</i>	Querschnitt Cross-Sect. [mm <sup>2</sup> ]	A [mm]	B [mm]	S [mm]	L [mm]	D [mm]	Bohrbild <i>Drilling</i>	Strombelastung <i>Current load</i>		
									ΔT 30 °C	ΔT 50 °C	ΔT 70 °C
FRS 600/020-400/60	FSS 600/020-400/60	600	100	60	16	400	13	D2	1120 A	1550 A	1900 A
FRS 600/020-400/70	FSS 600/020-400/70	600	120	70	14	400	13	D3	1160 A	1600 A	1970 A
FRS 600/020-400/80	FSS 600/020-400/80	600	80	80	12,5	400	13	D4	1210 A	1660 A	2040 A
FRS 600/020-400/90	FSS 600/020-400/90	600	120	90	11,5	400	13	D4	1250 A	1720 A	2110 A
FRS 600/020-400/100	FSS 600/020-400/100	600	100	100	10,5	400	13	D5	1290 A	1770 A	2180 A
FRS 600/020-450/120	FSS 600/020-450/120	600	120	120	9,5	450	13	D7	1360 A	1880 A	2300 A
FRS 600/020-450/140	FSS 600/020-450/140	600	120	140	9,3	450	13	D7	1430 A	1980 A	2430 A
FRS 600/020-450/150	FSS 600/020-450/150	600	120	150	8	450	13	D6	1460 A	2020 A	2480 A
FRS 600/020-450/160	FSS 600/020-450/160	600	120	160	8	450	13	D6	1500 A	2060 A	2530 A
FRS 600/020-500/200	FSS 600/020-500/200	600	120	200	10	500	13	D8	1620 A	2240 A	2750 A
FRS 800/020-400/80	FSS 800/020-400/80	800	80	80	15,5	400	13	D4	1410 A	1940 A	2380 A
FRS 800/020-400/100	FSS 800/020-400/100	800	100	100	13	400	13	D5	1500 A	2060 A	2530 A
FRS 800/020-450/120	FSS 800/020-450/120	800	120	120	11,5	450	13	D7	1580 A	2180 A	2680 A
FRS 800/020-450/140	FSS 800/020-450/140	800	120	140	11	450	13	D7	1660 A	2290 A	2810 A
FRS 800/020-450/150	FSS 800/020-450/150	800	120	150	10	450	13	D6	1700 A	2340 A	2880 A
FRS 800/020-450/160	FSS 800/020-450/160	800	120	160	11,2	450	13	D6	1740 A	2400 A	2950 A
FRS 800/020-500/200	FSS 800/020-500/200	800	120	200	11	500	13	D8	1880 A	2590 A	3180 A
FRS 1000/020-450/80	FSS 1000/020-450/80	1000	80	80	19	450	13	D4	1590 A	2200 A	2700 A
FRS 1000/020-450/100	FSS 1000/020-450/100	1000	100	100	15,5	450	13	D5	1690 A	2320 A	2850 A
FRS 1000/020-450/120	FSS 1000/020-450/120	1000	120	120	14,5	450	13	D7	1780 A	2450 A	3020 A
FRS 1000/020-500/140	FSS 1000/020-500/140	1000	120	140	13	500	13	D7	1870 A	2570 A	3160 A
FRS 1000/020-500/150	FSS 1000/020-500/150	1000	120	150	13,3	500	13	D6	1910 A	2630 A	3240 A
FRS 1000/020-500/160	FSS 1000/020-500/160	1000	120	160	12,8	500	13	D6	1950 A	2690 A	3310 A
FRS 1000/020-500/200	FSS 1000/020-500/200	1000	120	200	12,5	500	13	D8	2110 A	2900 A	3570 A
FRS 1200/020-450/100	FSS 1200/020-450/100	1200	100	100	18	450	15	D5	1860 A	2560 A	3150 A
FRS 1200/020-450/120	FSS 1200/020-450/120	1200	120	120	16,5	450	15	D7	1960 A	2700 A	3320 A
FRS 1200/020-500/140	FSS 1200/020-500/140	1200	120	140	14,6	500	15	D7	2050 A	2830 A	3480 A
FRS 1200/020-500/150	FSS 1200/020-500/150	1200	120	150	15	500	15	D6	2100 A	2900 A	3560 A
FRS 1200/020-500/160	FSS 1200/020-500/160	1200	120	160	14,3	500	15	D6	2150 A	2960 A	3630 A
FRS 1200/020-500/200	FSS 1200/020-500/200	1200	120	200	13,5	500	15	D8	2310 A	3180 A	3910 A
FRS 1500/020-450/100	FSS 1500/020-450/100	1500	120	100	22	450	15	D5	2110 A	2900 A	3570 A
FRS 1500/020-450/120	FSS 1500/020-450/120	1500	120	120	20	450	15	D7	2210 A	3050 A	3750 A
FRS 1500/020-500/140	FSS 1500/020-500/140	1500	120	140	16,2	500	15	D7	2300 A	3180 A	3900 A
FRS 1500/020-500/150	FSS 1500/020-500/150	1500	120	150	17,5	500	15	D6	2360 A	3260 A	4000 A
FRS 1500/020-500/160	FSS 1500/020-500/160	1500	120	160	16,6	500	15	D6	2410 A	3320 A	4080 A
FRS 1500/020-500/200	FSS 1500/020-500/200	1500	120	200	15,5	500	15	D8	2590 A	3570 A	4390 A
FRS 1800/020-450/120	FSS 1800/020-450/120	1800	120	120	23	450	15	D7	2440 A	3370 A	4140 A
FRS 1800/020-500/140	FSS 1800/020-500/140	1800	120	140	19	500	15	D7	2540 A	3500 A	4300 A
FRS 1800/020-500/150	FSS 1800/020-500/150	1800	120	150	20	500	15	D6	2600 A	3590 A	4410 A
FRS 1800/020-500/160	FSS 1800/020-500/160	1800	120	160	19	500	15	D6	2650 A	3660 A	4490 A
FRS 1800/020-500/200	FSS 1800/020-500/200	1800	120	200	17,5	500	15	D8	2850 A	3930 A	4830 A
FRS 2000/020-450/120	FSS 2000/020-450/120	2000	120	120	25	450	15	D7	2590 A	3570 A	4390 A
FRS 2000/020-500/140	FSS 2000/020-500/140	2000	120	140	21	500	15	D7	2690 A	3710 A	4560 A
FRS 2000/020-500/150	FSS 2000/020-500/150	2000	120	150	22	500	15	D6	2760 A	3800 A	4670 A
FRS 2000/020-500/160	FSS 2000/020-500/160	2000	120	160	21	500	15	D6	2810 A	3870 A	4760 A
FRS 2000/020-500/200	FSS 2000/020-500/200	2000	120	200	18,5	500	15	D8	3010 A	4150 A	5100 A
FRS 2200/020-450/120	FSS 2200/020-450/120	2200	120	120	27	450	15	D7	2730 A	3760 A	4620 A
FRS 2200/020-500/140	FSS 2200/020-500/140	2200	120	140	24,5	500	15	D7	2840 A	3920 A	4820 A
FRS 2200/020-500/150	FSS 2200/020-500/150	2200	120	150	23,5	500	15	D6	2900 A	4000 A	4910 A
FRS 2200/020-500/160	FSS 2200/020-500/160	2200	120	160	22	500	15	D6	2950 A	4070 A	5000 A
FRS 2200/020-500/200	FSS 2200/020-500/200	2200	120	200	20	500	15	D8	3170 A	4360 A	5360 A
FRS 2400/020-450/120	FSS 2400/020-450/120	2400	120	120	29	450	15	D7	2870 A	3950 A	4850 A
FRS 2400/020-500/140	FSS 2400/020-500/140	2400	120	140	26,5	500	15	D7	2980 A	4110 A	5050 A
FRS 2400/020-500/150	FSS 2400/020-500/150	2400	120	150	25	500	15	D6	3040 A	4190 A	5150 A
FRS 2400/020-500/160	FSS 2400/020-500/160	2400	120	160	24	500	15	D6	3100 A	4260 A	5240 A

Spezielle Bohrungen , Abmessungen und Ausführungen auf Anfrage / *Special drillings, dimensions and design upon request*

Strombelastungen sind circa Angaben (siehe Seite 28) / *Conductors current loads are approximated (please see page 28)*

Verwies auf Umgebungstemperatur 35° C / *Referred to Ambient Temperature 35° C*

# LAST - STROMBÄNDER POWER CONDUCTORS

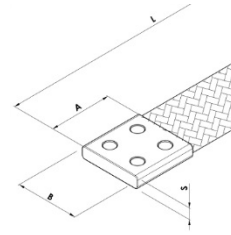

Kupfer blank Bare Copper	Kupfer verzinkt Tin-Plated Copper	Querschnitt Cross-Sect. [mm <sup>2</sup> ]	A [mm]	B [mm]	S [mm]	L [mm]	D [mm]	Bohrbild Drilling	Strombelastung Current load		
									ΔT 30°C	ΔT 50°C	ΔT 70°C
FRS 3000/020-450/120	FSS 3000/020-450/120	3000	120	120	33,5	450	15	D7	3240 A	4460 A	5480 A
FRS 3000/020-500/140	FSS 3000/020-500/140	3000	120	140	32	500	15	D7	3380 A	4650 A	5720 A
FRS 3000/020-500/150	FSS 3000/020-500/150	3000	120	150	30	500	15	D6	3430 A	4730 A	5810 A
FRS 3000/020-500/160	FSS 3000/020-500/160	3000	120	160	28,5	500	15	D6	3490 A	4810 A	5910 A
FRS 3600/020-450/120	FSS 3600/020-450/120	3600	120	120	40	450	15	D7	3600 A	4960 A	6100 A
FRS 3600/020-500/140	FSS 3600/020-500/140	3600	120	140	37	500	15	D7	3740 A	5150 A	6330 A
FRS 3600/020-500/150	FSS 3600/020-500/150	3600	120	150	35	500	15	D6	3800 A	5230 A	6430 A
FRS 3600/020-500/160	FSS 3600/020-500/160	3600	120	160	33	500	15	D6	3860 A	5320 A	6530 A
FRS 4500/020-450/120	FSS 4500/020-450/120	4500	120	120	50	450	15	D7	4120 A	5670 A	6970 A
FRS 4500/020-500/150	FSS 4500/020-500/150	4500	120	150	42,5	500	15	D6	4310 A	5940 A	7300 A
FRS 5000/020-450/120	FSS 5000/020-450/120	5000	120	120	55	450	15	D7	4930 A	6040 A	7430 A

## BOHRBILDER/DRILLING PATTERNS

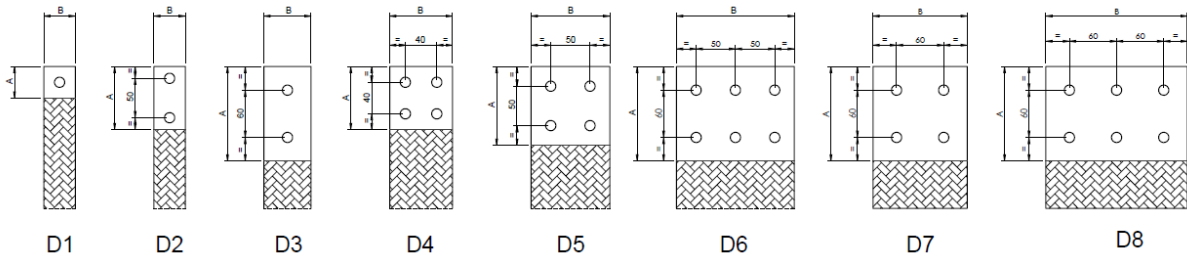

## TYPENERKLÄRUNGEN SPECIAL DESIGNATIONS

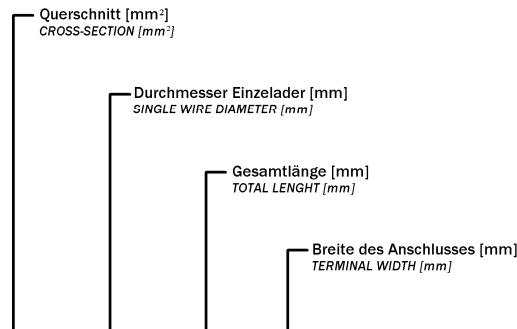

X Y Z U / W - L / B K

- R - Anschluss Kupfer blank  
BARE COPPER TERMINALS
- S - Anschluss Kupfer verzinkt  
TIN-PLATED COPPER TERMINALS
- A - Anschluss Kupfer versilbert  
SILVER-PLATED COPPER TERMINALS
- N - Anschluss Kupfer vernickelt  
NICKEL-PLATED COPPER TERMINALS

- R - Einzelader Kupfer blank  
BARE COPPER CONDUCTOR
- S - Einzelader Kupfer verzinkt  
TIN-PLATED COPPER CONDUCTOR

- F - Kupferzopf flach  
FLAT COPPER BRAID CONDUCTOR
- C - Kupferdraht verdreht  
TWISTED COPPER CABLE CONDUCTOR
- R - Kupferzopf rund  
ROUND COPPER BRAID CONDUCTOR



- SN - Verzinnter Anschluss  
HOT TIN DIPPED TERMINALS
- PVC - PVC Isolation  
PVC INSULATION
- PE - Polyolefin Thermo-Schrump Isolation  
POLYOLEFIN THERMOSHINKABLE INSULATION
- SIL - Silicon Isolation  
SILICON INSULATION
- FV - Fiberglass Isolation  
GLASS-FIBER INSULATION

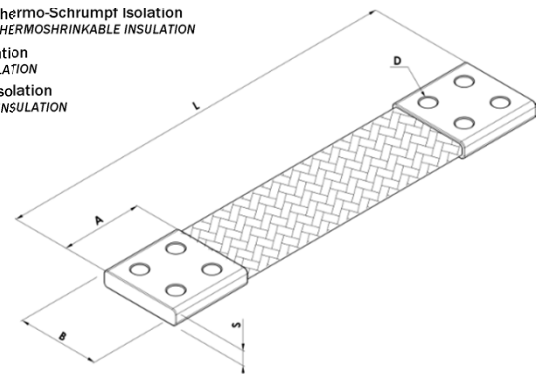

# ISOLIERTES KUPFERGEFLECHT - POWERFLEX

## INSULATED POWER CONDUCTORS- POWERFLEX



- Enden in Kupferhülsen verpresst / *Tin-plated copper tube terminals: Cu-DHP UNI EN 12499*
- Einzeldrahtstärke / *Single wire: Cu-ETP UNI EN 13602 - Ø 0,20 mm*
- PVC Isolierung schwarz / *Black PVC insulation*
- Selbstverlöschend / *Self extinguishing: UL 94 V0*
- Betriebsspannung / *Operating voltage: 1000 V AC - 1500 V DC*
- Temperaturbereich / *Operating temperature: -40/+105°C*
- Spannungsfestigkeit / *Dielectric strenght: 20 kV/mm*
- Dicke der Isolierung / *Insulation thickness: 1,6 - 2mm*
- Belastungen und Veränderungen bei  $\Delta T$  gemäß IEC 439 -  $T_a$  (Umgebungstemperatur) 35°C  
*Current loads referred to rise temperature  $\Delta T$  following IEC 439 norm -  $T_a$  ( Amb. Temp. ) 35° C*

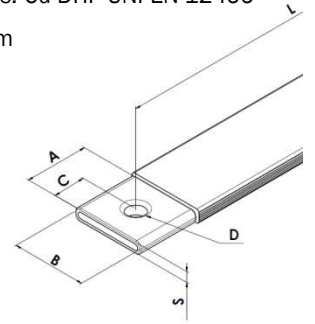

Kupfer blank <i>Bare Copper</i>	Kupfer verzinkt <i>Tin-Plated Copper</i>	Querschnitt <i>Cross-Sect.</i> [mm <sup>2</sup> ]	L [mm]	A [mm]	B [mm]	C [mm]	S [mm]	D [mm]	Strombelastung <i>Current load</i>		
									$\Delta T$ 30°C	$\Delta T$ 40°C	$\Delta T$ 50°C
PRS 16/020 - 230/12	PSS 16/020 - 230/12	16	230	14	12	7	3	6,5	93 A	110 A	127 A
PRS 16/020 - 330/12	PSS 16/020 - 330/12		330								
PRS 16/020 - 430/12	PSS 16/020 - 430/12		430								
PRS 16/020 - 530/12	PSS 16/020 - 530/12		530								
PRS 16/020 - 630/12	PSS 16/020 - 630/12		630								
PRS 16/020 - 730/12	PSS 16/020 - 730/12		730								
PRS 25/020- 230/12	PSS 25/020-230/12	25	230	14	12	7	5	6,5	119 A	144 A	161 A
PRS 25/020-330/12	PSS 25/020-330/12		330								
PRS 25/020-430/12	PSS 25/020-430/12		430								
PRS 25/020-530/12	PSS 25/020-530/12		530								
PRS 25/020-630/12	PSS 25/020-630/12		630								
PRS 25/020-730/12	PSS 25/020-730/12		730								
PRS 25/020-230/20	PSS 25/020-230/20	25	230	22	20	10	3,7	9 - 11	127 A	153 A	178 A
PRS 25/020-330/20	PSS 25/020-330/20		330								
PRS 25/020-430/20	PSS 25/020-430/20		430								
PRS 25/020-530/20	PSS 25/020-530/20		530								
PRS 25/020-630/20	PSS 25/020-630/20		630								
PRS 25/020-730/20	PSS 25/020-730/20		730								
PRS 35/020-230/20	PSS 35/020-230/20	35	230	22	20	10	4,5	9 - 11	153 A	187 A	212 A
PRS 35/020-330/20	PSS 35/020-330/20		330								
PRS 35/020-430/20	PSS 35/020-430/20		430								
PRS 35/020-530/20	PSS 35/020-530/20		530								
PRS 35/020-630/20	PSS 35/020-630/20		630								
PRS 35/020-730/20	PSS 35/020-730/20		730								
PRS 50/020-230/20	PSS 50/020-250/20	50	230	22	20	10	5,5	11	187 A	229 A	263 A
PRS 50/020-330/20	PSS 50/020-330/20		330								
PRS 50/020-430/20	PSS 50/020-430/20		430								
PRS 50/020-530/20	PSS 50/020-550/20		530								
PRS 50/020-630/20	PSS 50/020-630/20		630								
PRS 50/020-730/20	PSS 50/020-730/20		730								
PRS 50/020-830/20	PSS 50/020-830/20	830									
PRS 75/020-230/20	PSS 75/020-230/20	75	230	22	20	10	7	11	238 A	280 A	323 A
PRS 75/020-330/20	PSS 75/020-330/20		330								
PRS 75/020-430/20	PSS 75/020-430/20		430								
PRS 75/020-530/20	PSS 75/020-530/20		530								
PRS 75/020-630/20	PSS 75/020-630/20		630								
PRS 75/020-730/20	PSS 75/020-730/20		730								
PRS 75/020-830/20	PSS 75/020-830/20	830									
PRS 120/020-230/32	PSS 120/020-230/32	120	230	32	32	15	7	11	340 A	408 A	467 A
PRS 120/020-330/32	PSS 120/020-330/32		330								
PRS 120/020-430/32	PSS 120/020-430/32		430								
PRS 120/020-530/32	PSS 120/020-530/32		530								
PRS 120/020-630/32	PSS 120/020-630/32		630								
PRS 120/020-730/33	PSS 120/020-730/33		730								
PRS 120/020-830/32	PSS 120/020-830/32	830									
PRS 120/020-930/32	PSS 120/020-930/32	930									
PRS 240/020-230/32	PSS 240/020-230/32	240	230	32	32	15	12	13	500 A	595 A	688 A
PRS 240/020-330/32	PSS 240/020-330/32		330								
PRS 240/020-430/32	PSS 240/020-430/32		430								
PRS 240/020-530/32	PSS 240/020-530/32		530								
PRS 240/020-630/32	PSS 240/020-630/32		630								
PRS 240/020-730/32	PSS 240/020-730/32		730								
PRS 240/020-830/32	PSS 240/020-830/32	830									
PRS 240/020-930/32	PSS 240/020-930/32	930									

Andere Querschnitte. Längen und Bohrbilder auf Anfrage / *Special cross sections, lengths and terminal drillings upon request*  
Strombelastungen sind circa Angaben (siehe Seite 28) / *Conductors current loads are approximated (please see page 28)*

# ISOLIERTES KUPFERGEFLECHT - POWERFLEX S

## INSULATED POWER CONDUCTORS - POWERFLEX S

- Enden in Kupferhülsen verpresst / Tin-Plated *strip terminals*: Cu-ETP UNI EN 1652
- Einzeldrahtstärke / *Single wire*: Cu-ETP UNI EN 13602 - Ø 0,20 mm
- PVC Isolierung schwarz / *Black PVC insulation*
- Selbstverlöschend / *Self extinguishing*: UL 94 V0
- Betriebsspannung / *Operating voltage*: 1000 V AC – 1500 V DC
- Temperaturbereich / *Operating temperature*: -40/+105 °C
- Spannungsfestigkeit / *Dielectric strenght*: 20 kV/mm
- Dicke der Isolierung / *Insulation thickness*: 2 mm
- Belastungen und Veränderungen bei  $\Delta T$  gemäß IEC 439 – Ta (Umgebungstemperatur) 35 °C  
*Current loads referred to rise temperature  $\Delta T$  following IEC 439 norm – Ta (Amb. Temp.) 35 °C*

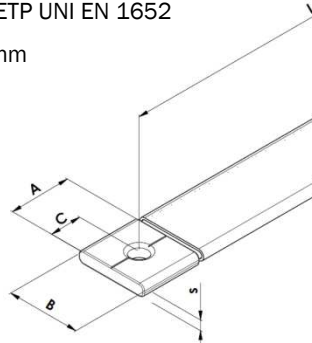

Kupfer blank <i>Bare Copper</i>	Kupfer verzinkt <i>Tin-Plated Copper</i>	Querschnitt <i>Cross-Sect.</i> [mm <sup>2</sup> ]	L [mm]	A [mm]	B [mm]	C [mm]	S [mm]	D [mm]	Strombelastung <i>Current load</i>		
									$\Delta T$ 30 °C	$\Delta T$ 40 °C	$\Delta T$ 50 °C
PR/S 16/17-230/9	PS 16/17-230/9	16	230	23	17	10	2,5	7	102 A	119 A	136 A
PR/S 16/17-330/9	PS 16/17-330/9		330								
PR/S 16/17-430/9	PS 16/17-430/9		430								
PR/S 16/17-530/9	PS 16/17-530/9		530								
PR/S 16/17-630/9	PS 16/17-630/9		630								
PR/S 25/23-200/9	PS 25/23-200/9	25	230	23	23	10	3,2	9-11	136 A	161 A	187 A
PR/S 25/23-330/9	PS 25/23-330/9		330								
PR/S 25/23-430/9	PS 25/23-430/9		430								
PR/S 25/23-530/9	PS 25/23-530/9		530								
PR/S 25/23-630/9	PS 25/23-630/9		630								
PR/S 35/23-230/9	PS 35/23-230/9	35	230	23	23	10	3,4	9-11	161 A	195 A	221 A
PR/S 35/23-330/9	PS 35/23-330/9		330								
PR/S 35/23-430/9	PS 35/23-430/9		430								
PR/S 35/23-530/9	PS 35/23-530/9		530								
PR/S 35/23-630/9	PS 35/23-630/9		630								
PR/S 50/23-230/11	PS 50/23-230/11	50	230	23	23	10	4,5	11	195 A	229 A	263 A
PR/S 50/23-330/11	PS 50/23-330/11		330								
PR/S 50/23-430/11	PS 50/23-430/11		430								
PR/S 50/23-530/11	PS 50/23-530/11		530								
PR/S 50/23-630/11	PS 50/23-630/11		630								
PR/S 75/23-230/11	PS 75/23-230/11	75	230	23	23	10	6	11	238 A	289 A	331 A
PR/S 75/23-330/11	PS 75/23-330/11		330								
PR/S 75/23-430/11	PS 75/23-430/11		430								
PR/S 75/23-530/11	PS 75/23-530/11		530								
PR/S 75/23-630/11	PS 75/23-630/11		630								
PR/S 100/30-230-13	PS 100/30-230-13	100	230	30	30	15	7	13	306 A	365 A	416 A
PR/S 100/30-330-13	PS 100/30-330-13		330								
PR/S 100/30-430-13	PS 100/30-430-13		430								
PR/S 100/30-530-13	PS 100/30-530-13		530								
PR/S 100/30-630-13	PS 100/30-630-13		630								
PR/S 150/30-230-13	PS 150/30-230-13	150	230	30	30	15	9,5	13	382 A	459 A	527 A
PR/S 150/30-330-13	PS 150/30-330-13		330								
PR/S 150/30-430-13	PS 150/30-430-13		430								
PR/S 150/30-530-13	PS 150/30-530-13		530								
PR/S 150/30-630-13	PS 150/30-630-13		630								

Andere Querschnitte. Längen und Bohrbilder auf Anfrage / *Special cross sections, lengths and terminal drillings upon request*  
Strombelastungen sind circa Angaben (siehe Seite 28) / *Conductors current loads are approximated (please see page 28)*

# ERDUNGSBÄNDER MIT KABELSCHUH

## PRESSED TERMINAL LUG CONDUCTORS



- Einzelader / *Single wire*: Cu-ETP UNI EN 13602
- Verzinnte Kabelschuhe / *Tin-plated terminal lugs*: Cu-ETP UNI EN 13600
- Spezielle Isolation auf Anfrage / *Special insulation upon request*

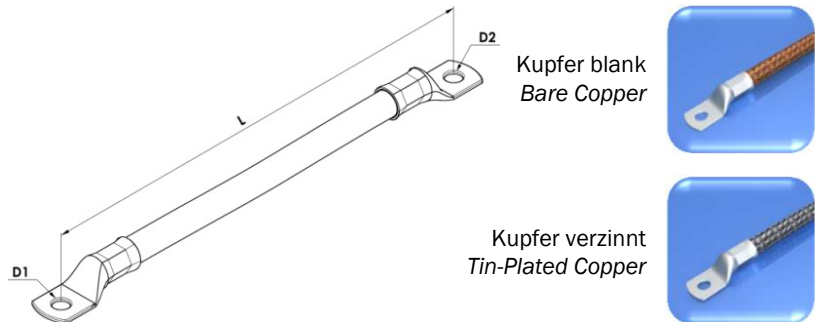

## RUNDGEFLECHT

### ROUND COPPER BRAID CONDUCTORS

Kupfer blank <i>Bare Copper</i>	Kupfer verzinkt <i>Tin-Plated Copper</i>	Querschnitt Cross-Sect. [mm <sup>2</sup> ]	Einzelader Single wire Ø [mm]	L [mm]	D1 [mm]	D2 [mm]	Strombelastung Current load ΔT 30 °C
LRR 10/020-200/M6	LRS 10/020-200/M6	10	0,20	200	6,4	6,4	75 A
LRR 16/020-200/M8	LRS 16/020-200/M8	16	0,20	200	8,4	8,4	110 A
LRR 25/020-200/M8	LRS 25/020-200/M8	25	0,20	200	8,4	8,4	140 A
LRR 35/020-250/M10	LRS 35/020-250/M10	35	0,20	250	10,5	10,5	185 A
LRR 50/020-250/M10	LRS 50/020-250/M10	50	0,20	250	10,5	10,5	240 A
LRR 75/020-300/M12	LRS 75/020-300/M12	75	0,20	300	13,2	13,2	285 A
LRR 100/020-300/M12	LRS 100/020-300/M12	100	0,20	300	13,2	13,2	350 A
LRR 120/020-350/M12	LRS 120/020-350/M12	120	0,20	350	13,2	13,2	390 A
LRR 150/020-350/M12	LRS 150/020-350/M12	150	0,20	350	13,2	13,2	450 A

## VERSEILTE KUPFERLEITER

### TWISTED COPPER CABLE CONDUCTORS

Kupfer blank <i>Bare Copper</i>	Kupfer verzinkt <i>Tin-Plated Copper</i>	Querschnitt Cross-Sect. [mm <sup>2</sup> ]	Einzelader Single wire Ø [mm]	L [mm]	D1 [mm]	D2 [mm]	Strombelastung Current load ΔT 30 °C
LCR 10/020-200/M6	LCS 10/020-200/M6	10	0,20	200	6,4	6,4	75 A
LCR 16/020-200/M8	LCS 16/020-200/M8	16	0,20	200	8,4	8,4	110 A
LCR 25/020-200/M8	LCS 25/020-200/M8	25	0,20	200	8,4	8,4	140 A
LCR 35/020-250/M10	LCS 35/020-250/M10	35	0,20	250	10,5	10,5	185 A
LCR 50/020-250/M10	LCS 50/020-250/M10	50	0,20	250	10,5	10,5	240 A
LCR 75/020-300/M12	LCS 75/020-300/M12	75	0,20	300	13,2	13,2	285 A
LCR 100/020-300/M12	LCS 100/020-300/M12	100	0,20	300	13,2	13,2	350 A
LCR 120/020-350/M12	LCS 120/020-350/M12	120	0,20	350	13,2	13,2	390 A
LCR 150/020-350/M12	LCS 150/020-350/M12	150	0,20	350	13,2	13,2	450 A

Sonderausführungen auf Anfrage / *Special dimensions and design upon request*

Strombelastungen sind circa Angaben (siehe Seite 28) / *Conductors current loads are approximated (please see page 28)*

Verwies auf Umgebungstemperatur 35 ° C / *Referred to Ambient Temperature 35 °C*

# LUFTGEKÜHLTE STROMBÄNDER AIR-COOLED CABLES

- Einzelader Cu-ETP UNI EN 13602 - Ø 0,10/0,20 mm  
*Single wire Cu-ETP UNI EN 13602 - Ø 0,10/0,20 mm*
- Kupferseil blank - Verzinnte Kupferendhülsen  
*Twisted bare copper cable - Tubular tin-plated copper terminals*
- Textilverstärkte Gummischlauch-Isolation  
*Textile reinforced rubber tube insulation*
- Spezielle Isolation auf Anfrage  
*Special insulation upon request*
- Große Liefertreue  
*Punctual deliveries*

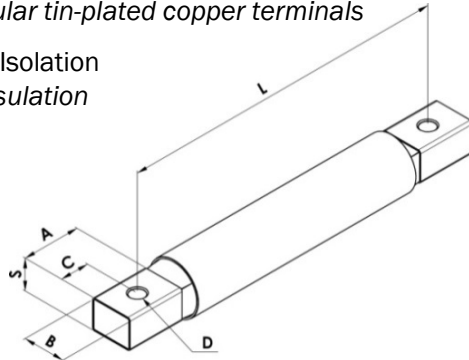

## SONDER.- / KUNDENAUSFÜHRUNGEN CUSTOM-MADE SOLUTIONS

Typ Item	Querschnitt Cross-Section [mm <sup>2</sup> ]	A [mm]	B [mm]	C [mm]	S [mm]	Bohrbild Drilling	D [mm]
FCA 150 - L	150	50	32	16	8,0	D1	13
FCA 200 - L	200				10,0		
FCA 300 - L	300				14,0		
FCA 400 - L	400				18,0		
FCA 500 - L	500				22,0		
FCA 600 - L	600				26,0		

Im Auftragsfall die Maße "L" einfügen (lochabstand) / *Please insert "L" dimension (distance between holes) in your orders*  
 Sonderausführungen auf Anfrage / *Special dimensions and design upon request*  
 Wassergekühlte Leiter auf Anfrage / *Water cooled cables produced upon request*

## STANDART AUSFÜHRUNG STANDARD DIMENSIONS

Typ Item	Querschnitt Cross-Section [mm <sup>2</sup> ]	A [mm]	B [mm]	C [mm]	S [mm]	L [mm]	D [mm]
FCA 300-250	300	50	32	16	14	250	13
FCA 300-300						300	
FCA 300-350						350	
FCA 300-400						400	
FCA 300-450						450	
FCA 300-500						500	
FCA 400-250	400	50	32	16	18	250	13
FCA 400-300						300	
FCA 400-350						350	
FCA 400-400						400	
FCA 400-450						450	
FCA 400-500						500	
FCA 500-300	500	50	32	16	22	300	13
FCA 500-350						350	
FCA 500-400						400	
FCA 500-450						450	
FCA 500-500						500	
FCA 500-600						600	
FCA 600-400	600	50	32	16	26	400	13
FCA 600-450						450	
FCA 600-500						500	
FCA 600-550						550	
FCA 600-600						600	
FCA 600-700						700	

# PRESS-VERZINNTE LAMELLIERTE STROMBÄNDER

## PRESS-TINNED LAMINATED SHUNTS



PLR - PLS

- Längenkompensationsbänder - Press-verzinnnte Strombänder  
*Compensation shunts - Press-tinned terminals*
- Geglühte Kupferfolie UNI EN 1652 stärke 0,3/0,5 mm  
*H40 Cu-ETP UNI EN 1652 strips thickness 0,3/0,5 mm*

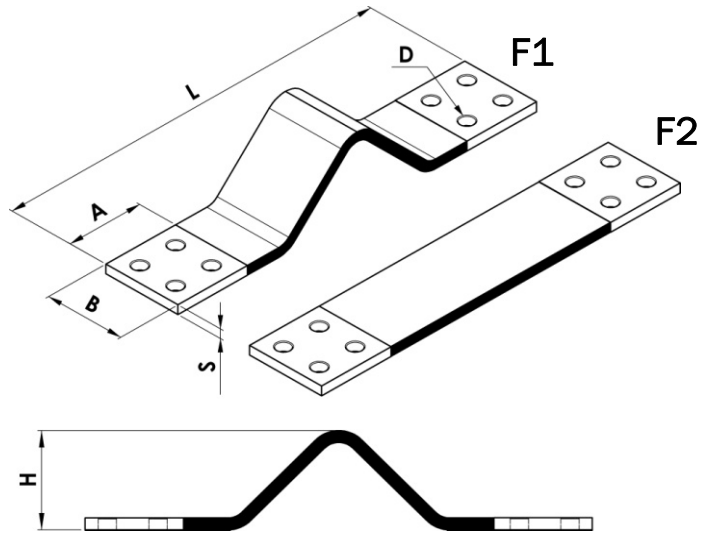

- Sonderausführungen auf Anfrage  
*Special dimensions and design upon request*
- Isolation auf Anfrage  
*Insulation upon request*
- Galvanisierte Oberflächen auf Anfrage  
*Galvanic coating upon request*

Kupfer blank <i>Bare Copper</i>	Kupfer verzinkt <i>Tin-Plated Copper</i>	Querschnitt <i>Cross-Sect.</i> [mm <sup>2</sup> ]	A [mm]	B [mm]	S [mm]	L [mm]	H (F1) [mm]	D [mm]	Bohrbild <i>Drilling</i>	Strombelastung <i>Current load</i>		
										ΔT 30 °C	ΔT 50 °C	ΔT 70 °C
PLR 100-200 F1	PLS 100-200 F1	100	50	50	2	200	30	13	D1	400 A	550 A	680 A
PLR 150-250 F1	PLS 150-250 F1	150	50	50	3	250	40	13	D1	490 A	680 A	840 A
PLR 200-300 F1	PLS 200-300 F1	200	50	50	4	300	50	13	D1	570 A	790 A	970 A
PLR 250-300 F1	PLS 250-300 F1	250	50	50	5	300	50	13	D1	650 A	890 A	1100 A
PLR 400-400 F1	PLS 400-400 F1	400	80	80	5	400	70	13	D4	950 A	1320 A	1620 A
PLR 500-400 F1	PLS 500-400 F1	500	80	80	6,3	400	70	13	D4	1070 A	1480 A	1820 A
PLR 600-400 F1	PLS 600-400 F1	600	80	80	7,5	400	70	13	D4	1180 A	1630 A	2000 A
PLR 800-400 F1	PLS 800-400 F1	800	80	80	10	400	70	13	D4	1380 A	1900 A	2330 A
PLR 1000-450 F1	PLS 1000-450 F1	1000	100	100	10	450	70	13	D5	1660 A	2280 A	2800 A
PLR 1200-450 F1	PLS 1200-450 F1	1200	100	100	12	450	70	13	D5	1830 A	2520 A	3090 A
PLR 1500-500 F1	PLS 1500-500 F1	1500	120	120	12,5	500	70	13	D7	2170 A	2990 A	3670 A
PLR 1800-500 F1	PLS 1800-500 F1	1800	120	120	15	500	70	13	D7	2390 A	3300 A	4050 A
PLR 2000-500 F1	PLS 2000-500 F1	2000	120	120	16,7	500	70	13	D7	2530 A	3490 A	4290 A

Bestellbeispiel für Lochbild F2: PLR 100-200 F2 / *Example of ordering code for F2 type: PLR 100-200 F2*

Sonderausführungen und Abmessungen auf Anfrage / *Special dimensions and design upon request*

Strombelastungen sind circa Angaben (siehe Seite 28) / *Conductors current loads are approximated (please see page 28)*

Verwies auf Umgebungstemperatur 35 ° C / *Referred to Ambient Temperature 35 ° C*

### BOHRBILDER / DRILLING PATTERNS

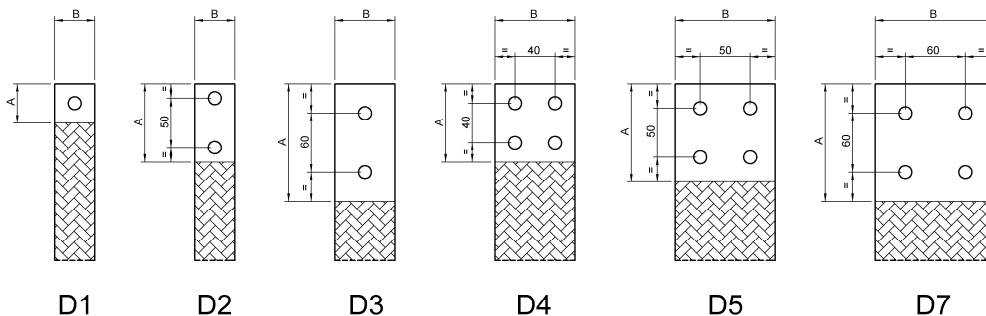



# PRESS-VERSCHWEISSTE LAMELLIERTE STROMBÄNDER

## PRESSWELDED LAMINATED SHUNTS

- Längenkompensationsbänder – Pressverschweisst  
*Compensation shunts - Presswelded terminals*
- Geglühte Kupferfolie UNI EN 1652 stärke 0,3/0,5 mm  
*H40 Cu-ETP UNI EN 1652 strips thickness 0,3/0,5 mm*

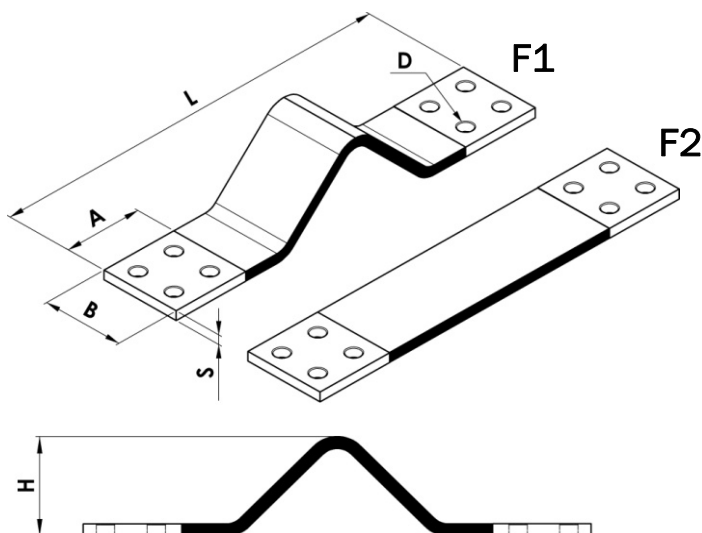

- Sonderausführungen auf Anfrage  
*Special design upon request*
- Isolation auf Anfrage  
*Insulation upon request*
- Galvanisierte Oberflächen auf Anfrage  
*Galvanic coating upon request*

Kupfer blank Bare Copper	Querschnitt Cross-Sect. [mm <sup>2</sup> ]	A [mm]	B [mm]	S [mm]	L [mm]	H (F1) [mm]	D [mm]	Bohrbild Drilling	Strombelastung Current load		
									ΔT 30 °C	ΔT 50 °C	ΔT 70 °C
PWD 100-200 F1	100	50	50	2	200	30	13	D1	400 A	550 A	680 A
PWD 150-250 F1	150	50	50	3	250	40	13	D1	490 A	680 A	840 A
PWD 200-300 F1	200	50	50	4	300	50	13	D1	570 A	790 A	970 A
PWD 250-300 F1	250	50	50	5	300	50	13	D1	650 A	890 A	1100 A
PWD 400-400 F1	400	80	80	5	400	70	13	D4	950 A	1320 A	1620 A
PWD 500-400 F1	500	80	80	6,3	400	70	13	D4	1070 A	1480 A	1820 A
PWD 600-400 F1	600	80	80	7,5	400	70	13	D4	1180 A	1630 A	2000 A
PWD 800-400 F1	800	80	80	10	400	70	13	D4	1380 A	1900 A	2330 A
PWD 1000-450 F1	1000	100	100	10	450	70	13	D5	1660 A	2280 A	2800 A
PWD 1200-450 F1	1200	100	100	12	450	70	13	D5	1830 A	2520 A	3090 A
PWD 1500-500 F1	1500	120	120	12,5	500	70	13	D7	2170 A	2990 A	3670 A
PWD 1800-500 F1	1800	120	120	15	500	70	13	D7	2390 A	3300 A	4050 A
PWD 2000-500 F1	2000	120	120	16,7	500	70	13	D7	2530 A	3490 A	4290 A

Bestellbeispiel für Lochbild F2: PWD 100-200 F2 / *Ordering code for F2 type: PWD 100-200 F2*

Sonderausführungen und Abmessungen auf Anfrage / *Special dimensions and design upon request*

Strombelastungen sind circa Angaben (siehe Seite 28) / *Conductors current loads are approximated (please see page 28)*

Verwies auf Umgebungstemperatur 35 ° C / *Referred to Ambient Temperature 35 ° C*

## LAMELLIERTE BÄNDER IN SONDERAUSFÜHRUNG

### SPECIAL LAMINATED SHUNTS

- Lamellierte Bänder nach Kundenzeichnung  
*Laminated shunts according customers' drawing*
- Ausführungen MIG - MAG / TIG geschweißt  
*Special MIG-MAG/TIG welded terminals shunts*
- Bänder aus Aluminium Typ EN AW 1050A  
*EN AW 1050A aluminium shunts*



# GEFORMTE / BEWEGLICHE STROMBÄNDER

## MOVING LAMINATED SHUNTS



- Große Vielfalt in der Anwendung  
*Wide range of products*
- Lösungen nach Kundenanforderungen  
*Custom-made solutions*



- Zertifizierter Ursprung  
*Certified Origin of Materials*
- Große Liefertreue  
*Punctual deliveries*



- Lamellen Cu-ETP H90 UNI EN 1652  
*H90 Cu-ETP UNI EN 1652 strips*
- Anschlusschülse Press-verzinkt oder Press-verschweißt  
*Riveted, press-tinned or presswelded terminals*
- Lamellierte hochflexible Kupferbänder verzinkt oder versilbert für hohe Flexibilität ansprüche  
*Made in BARE, TIN-PLATED, SILVER-PLATED Copper for the highest efficiency of electric machines*
- Anfertigung nach Muster oder Zeichnung  
*Manufactured from drawings or samples*
- Herstellungsprozess nach der Methode FEM (Finite Elemente Methode)  
*Manufacturing processes optimized by FEM analysis (Finite Element Method)*

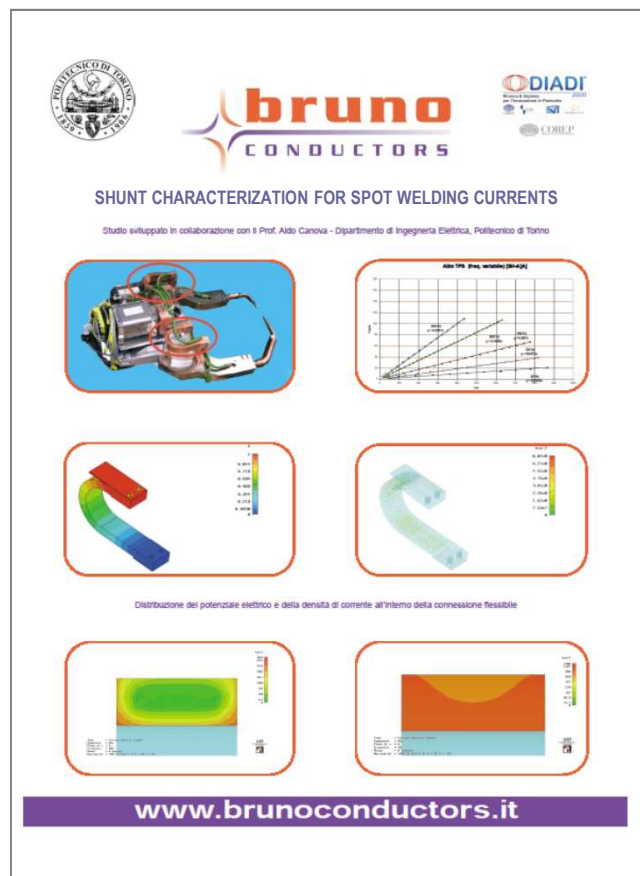

### SPEZIELLE KÜHLKÖRPER FÜR WASSERKÜHLUNG

#### SPECIAL WATER-COOLED SHUNTS

Große Kühlkörper speziell entwickelt für Hochleistungsanwendungen mit Wasserkühlung bei Anwendungen wie Widerstandsschweißen usw.

*Very large cross-section lamellar shunts with water-cooled dissipator terminals designed for high-power resistance welding machines.*

## WASSER UND LUFT-KÜHLKÖRPER WATER AND AIR-COOLED HEAT DISSIPATOR

Abführung und Nutzung der Abwärme durch die Medien Luft und Wasser

Heat can be wasted thanks to the raw material thermal conductivity (copper or aluminium), to the cooling plant peculiarity and to the convective current generated in the air around the shunt cooler.

Entwickelt, um die Wirtschaftlichkeit von flexiblen Leitern zu erhöhen und dauerhaft zu verbessern.

It is designed to improve the duration and the efficiency of flexible conductors used in hard work applications.

Verteilte Klemmkraft verbessert die elektrische Verbindung.

It improves the connection between electrical contact areas thanks to the distributed clamping strength.

Entwickelt für spezielle Kundenanforderungen  
Designed for customers' special needs

Sonderausführungen möglich  
Custom-made solutions

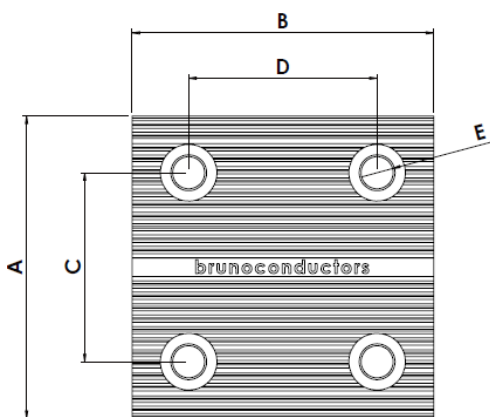
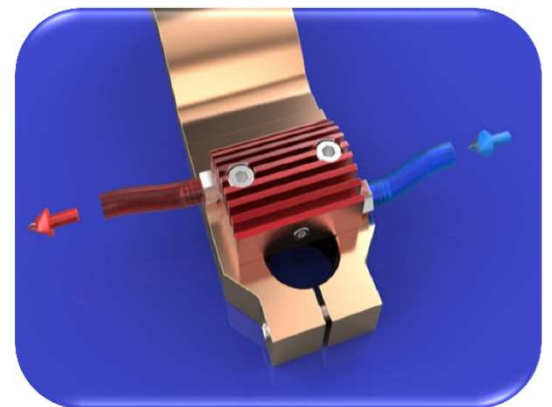
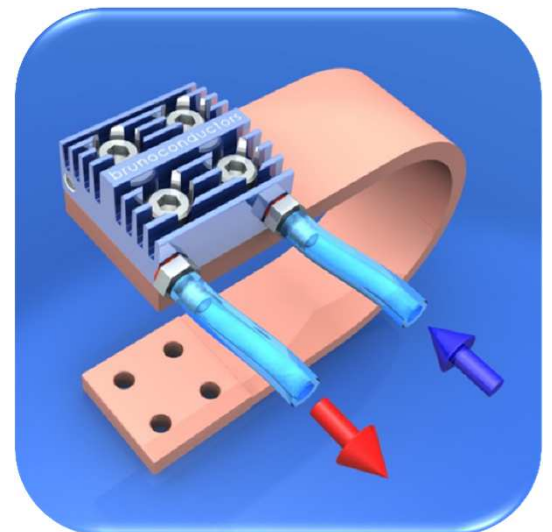
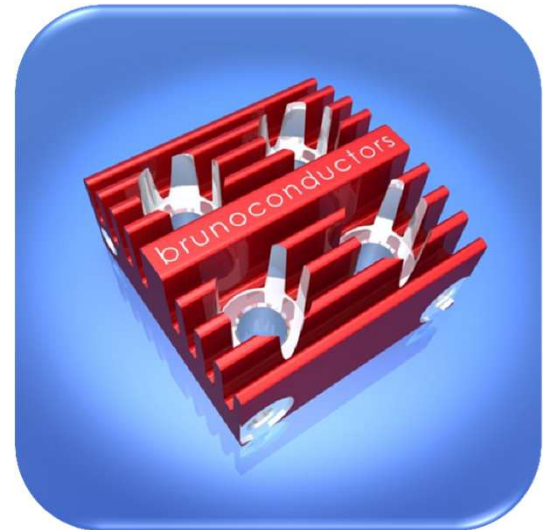
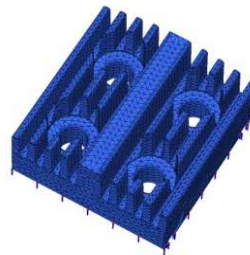
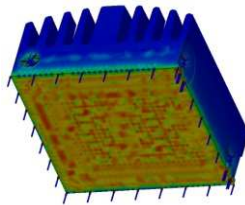

Luft Air	Luft - Wasser Air - Water	A [mm]	B [mm]	C [mm]	D [mm]	E [mm]	F [mm]	
							SCA	SCH
SCA 50-50	SCH 50-50	50	50	25	25	8,5	25	30
SCA 60-60	SCH 60-60	60	60	30	30	8,5	25	30
SCA 80-80	SCH 80-80	80	80	40	40	13	25	30
SCA 100-100	SCH 100-100	100	100	50	50	13	25	30
SCA 120-120	SCH 120-120	120	120	60	60	13	25	30

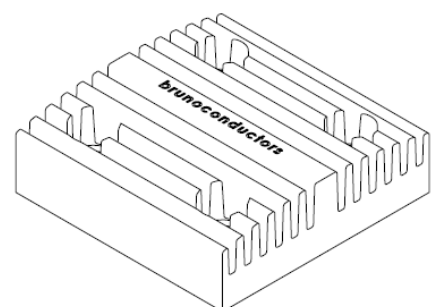

Sonderausführungen und Abmessungen auf Anfrage / Special dimensions and design upon request

# ISOLIERTE LAMELLIERTE STROMBÄNDER

## INSULATED FLEXIBLE BARS



- Lamelliertes Kupferband nach Cu-ETP UNI EN 1652  
*Single strip Cu-ETP UNI EN 1652*
- PVC Isolierung schwarz selbstverlöschend gem. UL 94 V0  
*Self extinguishing UL 94 V0 black PVC insulation*
- Betriebsspannung bis 1000 V AC – 1500 V DC  
*Operating voltage 1000 V AC – 1500 V DC*
- Temperaturbereich -40/+105 °C  
*Operating temperature -40/+105 °C*
- Spannungsfestigkeit 20 kV/mm  
*Dielectric strength 20 kV/mm*
- Isolationsstärke: 1,6 - 2 mm  
*Insulation thickness: 1,6 - 2 mm*
- Halogen freie Isolation / Silikon Isolation auf Anfrage  
*Halogen free / Silicon Insulation upon request*
- Standardlänge : 2 metri (Sonderlänge auf Anfrage)  
*Standard bar length: 2 meters (specials upon request)*
- Verzinnete Kupfer,- Aluminiumbänder auf Anfrage  
*Tin-plated Copper or Aluminium flexible bars upon request*

### Bezogen auf die Umgebungstemperatur von 35°C gemäß DIN 43671

Strombelastbarkeit bezogen auf die Stromschienentemperatur = Temperaturanstieg  $\Delta T$  (aufgrund des Stromflusses) + aktuelle Umgebungstemperatur

### Referred to ambient temperature of 35°C following DIN 43671 norm

Current load is referred to conductor temperature = temperature rise  $\Delta T$  + referred ambient temperature

### K\* = Koeffizient bei Parallelführung von mehreren Bändern

z.B. : 32x5x1 In a  $\Delta T$  50°C = 617 A

Zweifach parallel 32x5x1 In = 617 A x 1,72 = 1061 A

Dreifach parallel 32x5x1 In = 617 A x 2,25 = 1388 A

### K\* = derating coefficient for using bars in parallel

example : 32x5x1 In at  $\Delta T$  50°C = 617 A

for n° 2 bars 32x5x1 in parallel In = 617 A x 1,72 = 1061 A

for n° 3 barre 32x5x1 in parallel In = 617 A x 2,25 = 1388 A

### Kurzschlußfestigkeit (Icc) für isolierte Bänder: Vergleichswerte

Jeweils 1 flexibles Element je Phase

Anfangstemperatur: 105 °C maximal Dauertemperatur

Endtemperatur: 160 °C Maximale Temperatur bei PVC isolierten Bändern gemäß IEC 60724 Querschnitt <300 mm<sup>2</sup>

Endtemperatur: 140 °C Maximale Temperatur bei PVC isolierten Bändern gemäß IEC 60724 Querschnitt >300 mm<sup>2</sup>

Icc: Kurzschlußstrom in kA - t = 1 sec (Dauer des Kurzschlusses in Sekunden)

### Short circuit current (Icc) for Insulated flexible bars : benchmarks

One flexible element per phase

Initial temperature: 105 °C - maximal operating temperature of the conductor

Final temperature: 160 °C - temperature limit of the insulation material PVC in accordance with IEC 60724 if cross section < 300mm<sup>2</sup>

Final temperature: 140 °C - temperature limit of the insulation material PVC in accordance with IEC 60724 if cross section > 300mm<sup>2</sup>

Icc: value of short circuit current in kA - t = 1 s (duration of short circuit in seconds)

Zertifikate:

Approval:  File no. E366472

## VORGEFERTIGTE ISOLIERTER SONDERAUSFÜHRUNGEN

### PREFABRICATED FLEXIBLE BAR CONNECTIONS

Sonderausführungen nach Kundenanforderung, Muster und Zeichnung auf Anfrage.

We can also realize special flexible bar conductors according customers' requirements.



# BARRE FLESSIBILI ISOLATE

## INSULATED FLEXIBLE BARS

Typ Item	Abmessung Dimensions	Breite		Stärke		Schichten Querschnitt		Strombelastung in Bezug im Belastungstempertur-Moment ΔT					K *		Icc kA
		Width	x	Thick.	x	Strips	Section	Current Load following Temperature Rise ΔT					n° 2	n° 3	
								[mm]	[No.]	[mm <sup>2</sup> ]	30 °C	40 °C			
FB 09-2	9x0,8x2	9	x	0,8	x	2	14,4	95 A	114 A	130 A	144 A	157 A	1,72	2,25	1,25
FB 09-3	9x0,8x3	9	x	0,8	x	3	21,6	119 A	140 A	162 A	180 A	195 A	1,72	2,25	1,88
FB 09-6	9x0,8x6	9	x	0,8	x	6	43,2	176 A	210 A	240 A	256 A	290 A	1,72	2,25	3,75
FB 09-9	9x0,8x9	9	x	0,8	x	9	64,8	225 A	268 A	306 A	340 A	370 A	1,72	2,25	5,63
FB 13-2	13x0,5x2	13	x	0,5	x	2	13	97 A	116 A	132 A	147 A	160 A	1,72	2,25	1,13
FB 13-3	13x0,5x3	13	x	0,5	x	3	19,5	120 A	143 A	163 A	180 A	198 A	1,72	2,25	1,70
FB 13-4	13x0,5x4	13	x	0,5	x	4	26	140 A	166 A	190 A	210 A	230 A	1,72	2,25	2,26
FB 13-6	13x0,5x6	13	x	0,5	x	6	39	174 A	207 A	237 A	263 A	288 A	1,72	2,25	3,40
FB 13-10	13x0,5x10	13	x	0,5	x	10	65	232 A	275 A	316 A	350 A	363 A	1,72	2,25	5,65
FB 16-2	15,5x0,8x2	15,5	x	0,8	x	2	24,8	140 A	168 A	192 A	214 A	234 A	1,72	2,25	2,15
FB 16-3	15,5x0,8x3	15,5	x	0,8	x	3	37,2	175 A	209 A	239 A	255 A	290 A	1,72	2,25	3,23
FB 16-4	15,5x0,8x4	15,5	x	0,8	x	4	49,6	205 A	244 A	279 A	310 A	339 A	1,72	2,25	4,31
FB 16-6	15,5x0,8x6	15,5	x	0,8	x	6	74,4	257 A	306 A	350 A	389 A	424 A	1,72	2,25	6,47
FB 16-8	15,5x0,8x8	15,5	x	0,8	x	8	99,2	303 A	360 A	412 A	458 A	500 A	1,72	2,25	8,90
FB 16-10	15,5x0,8x10	15,5	x	0,8	x	10	124	345 A	410 A	470 A	523 A	570 A	1,72	2,25	10,78
FB 20-2	20x1x2	20	x	1	x	2	40	193 A	220 A	263 A	292 A	319 A	1,72	2,25	3,48
FB 20-3	20x1x3	20	x	1	x	3	60	240 A	285 A	326 A	363 A	396 A	1,72	2,25	5,22
FB 20-4	20x1x4	20	x	1	x	4	80	280 A	324 A	381 A	424 A	463 A	1,72	2,25	6,96
FB 20-5	20x1x5	20	x	1	x	5	100	316 A	377 A	430 A	479 A	523 A	1,72	2,25	8,70
FB 20-6	20x1x6	20	x	1	x	6	120	350 A	418 A	477 A	521 A	580 A	1,72	2,25	10,43
FB 20-8	20x1x8	20	x	1	x	8	160	412 A	492 A	562 A	625 A	683 A	1,72	2,25	13,91
FB 20-10	20x1x10	20	x	1	x	10	200	470 A	560 A	640 A	710 A	776 A	1,72	2,25	17,40
FB 24-2	24x1x2	24	x	1	x	2	48	223 A	255 A	303 A	337 A	368 A	1,72	2,25	4,17
FB 24-3	24x1x3	24	x	1	x	3	72	276 A	329 A	375 A	417 A	456 A	1,72	2,25	6,26
FB 24-4	24x1x4	24	x	1	x	4	96	322 A	383 A	438 A	487 A	532 A	1,72	2,25	8,35
FB 24-5	24x1x5	24	x	1	x	5	120	363 A	438 A	494 A	550 A	600 A	1,72	2,25	10,43
FB 24-6	24x1x6	24	x	1	x	6	144	402 A	479 A	547 A	608 A	664 A	1,72	2,25	12,52
FB 24-8	24x1x8	24	x	1	x	8	192	470 A	552 A	641 A	713 A	779 A	1,72	2,25	16,70
FB 24-10	24x1x10	24	x	1	x	10	240	534 A	637 A	727 A	809 A	883 A	1,72	2,25	20,87
FB 32-2	32x1x2	32	x	1	x	2	64	280 A	334 A	382 A	424 A	463 A	1,72	2,25	5,57
FB 32-3	32x1x3	32	x	1	x	3	96	346 A	413 A	470 A	524 A	572 A	1,72	2,25	8,35
FB 32-4	32x1x4	32	x	1	x	4	128	402 A	480 A	548 A	610 A	668 A	1,72	2,25	11,13
FB 32-5	32x1x5	32	x	1	x	5	160	453 A	540 A	617 A	686 A	749 A	1,72	2,25	13,91
FB 32-6	32x1x6	32	x	1	x	6	192	500 A	596 A	680 A	756 A	826 A	1,72	2,25	16,70
FB 32-8	32x1x8	32	x	1	x	8	256	583 A	695 A	793 A	882 A	963 A	1,72	2,25	22,26
FB 32-10	32x1x10	32	x	1	x	10	320	657 A	783 A	894 A	995 A	1085 A	1,72	2,25	22,50
FB 40-2	40x1x2	40	x	1	x	2	80	337 A	401 A	458 A	510 A	556 A	1,72	2,25	6,96
FB 40-3	40x1x3	40	x	1	x	3	120	415 A	494 A	565 A	628 A	686 A	1,72	2,25	10,44
FB 40-4	40x1x4	40	x	1	x	4	160	480 A	574 A	655 A	729 A	796 A	1,72	2,25	13,91
FB 40-5	40x1x5	40	x	1	x	5	200	540 A	644 A	736 A	818 A	894 A	1,72	2,25	17,39
FB 40-6	40x1x6	40	x	1	x	6	240	594 A	708 A	809 A	900 A	982 A	1,72	2,25	20,87
FB 40-8	40x1x8	40	x	1	x	8	320	690 A	822 A	939 A	1044 A	1140 A	1,72	2,25	22,50
FB 40-10	40x1x10	40	x	1	x	10	400	774 A	922 A	1053 A	1171 A	1279 A	1,65	2,12	28,12
FB 50-3	50x1x3	50	x	1	x	3	150	498 A	594 A	679 A	755 A	824 A	1,72	2,25	13,04
FB 50-4	50x1x4	50	x	1	x	4	200	577 A	688 A	786 A	874 A	954 A	1,72	2,25	17,39
FB 50-5	50x1x5	50	x	1	x	5	250	645 A	770 A	880 A	978 A	1058 A	1,72	2,25	21,10
FB 50-6	50x1x6	50	x	1	x	6	300	709 A	844 A	965 A	1073 A	1170 A	1,65	2,12	21,74
FB 50-8	50x1x8	50	x	1	x	8	400	818 A	975 A	1114 A	1238 A	1352 A	1,65	2,12	28,12
FB 50-10	50x1x10	50	x	1	x	10	500	914 A	1089 A	1244 A	1383 A	1510 A	1,72	2,12	35,15
FB 63-3	63x1x3	63	x	1	x	3	189	604 A	720 A	823 A	915 A	998 A	1,65	2,12	16,44
FB 63-4	63x1x4	63	x	1	x	4	252	698 A	832 A	960 A	1058 A	1153 A	1,65	2,12	21,92
FB 63-5	63x1x5	63	x	1	x	5	315	779 A	929 A	1050 A	1179 A	1288 A	1,65	2,12	22,14
FB 63-6	63x1x6	63	x	1	x	6	378	852 A	1015 A	1159 A	1289 A	1408 A	1,65	2,12	26,57
FB 63-8	63x1x8	63	x	1	x	8	504	978 A	1166 A	1332 A	1480 A	1617 A	1,65	2,12	35,43
FB 63-10	63x1x10	63	x	1	x	10	630	1088 A	1295 A	1480 A	1646 A	1796 A	1,65	2,12	44,29
FB 80-3	80x1x3	80	x	1	x	3	240	729 A	880 A	1005 A	1119 A	1220 A	1,65	2,12	20,88
FB 80-4	80x1x4	80	x	1	x	4	320	850 A	1014 A	1158 A	1286 A	1405 A	1,65	2,12	22,50
FB 80-5	80x1x5	80	x	1	x	5	400	947 A	1128 A	1289 A	1433 A	1565 A	1,65	2,12	28,12
FB 80-6	80x1x6	80	x	1	x	6	480	1032 A	1228 A	1404 A	1562 A	1705 A	1,65	2,12	33,74
FB 80-8	80x1x8	80	x	1	x	8	640	1179 A	1405 A	1504 A	1784 A	1948 A	1,65	2,12	44,99
FB 80-10	80x1x10	80	x	1	x	10	800	1305 A	1556 A	1776 A	1976 A	2156 A	1,65	2,12	56,24
FB 100-4	100x1x4	100	x	1	x	4	400	1089 A	1297 A	1480 A	1648 A	1799 A	1,6	2,02	29,55
FB 100-5	100x1x5	100	x	1	x	5	500	1135 A	1354 A	1545 A	1720 A	1878 A	1,6	2,02	35,15
FB 100-6	100x1x6	100	x	1	x	6	600	1235 A	1470 A	1680 A	1869 A	2040 A	1,6	2,02	42,18
FB 100-8	100x1x8	100	x	1	x	8	800	1404 A	1674 A	1912 A	2125 A	2320 A	1,6	2,02	56,24
FB 100-10	100x1x10	100	x	1	x	10	1000	1550 A	1848 A	2110 A	2347 A	2562 A	1,6	2,02	70,30
FB 100-12	100x1x12	100	x	1	x	12	1200	1680 A	2002 A	2267 A	2543 A	2776 A	1,6	2,02	84,36
FB 120-4	120x1x4	120	x	1	x	4	480	1135 A	1350 A	1544 A	1718 A	1875 A	1,6	2,02	33,98
FB 120-5	120x1x5	120	x	1	x	5	600	1358 A	1615 A	1848 A	2055 A	2244 A	1,6	2,02	40,42
FB 120-6	120x1x6	120	x	1	x	6	720	1420 A	1690 A	1932 A	2148 A	2345 A	1,6	2,02	48,50
FB 120-8	120x1x8	120	x	1	x	8	960	1614 A	1925 A	2198 A	2443 A	2668 A	1,5	1,95	64,68
FB 120-10	120x1x10	120	x	1	x	10	1200	1848 A	2200 A	2490 A	2795 A	3053 A	1,5	1,95	80,85

# WERKZEUGE / ZUBEHÖR TOOLS

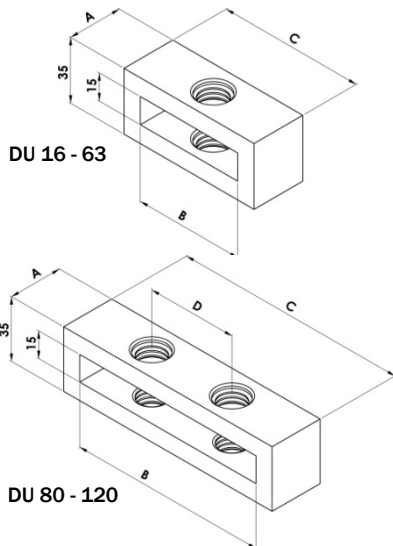

DU 16 - 63

DU 80 - 120

## BOHREINHEIT - DRILLING UNIT

Typ Item	Schiene Max. Max. Bar	A [mm]	B [mm]	C [mm]	D [mm]
DU 16	15,5x0,8x10	25	16	50	-
DU 20	20x1x10	25	20,5	50	-
DU 24	24x1x10	25	24,5	50	-
DU 32	32x1x10	30	32,5	65	-
DU 40	40x1x10	30	40,5	70	-
DU 50	50x1x10	30	50,5	80	-
DU 63	63x1x10	40	63,5	95	-
DU 80	80x1x10	40	80,5	110	40
DU 100	100x1x10	50	101	130	50
DU 120	120x1x10	50	121	150	60

Bohrer nicht enthalten (DG) / Drill guide DG not included

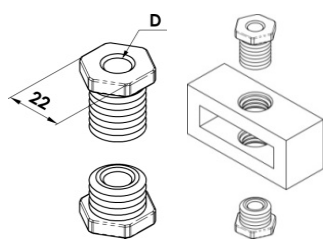

## BOHREINSÄTZE DRILL GUIDE

Typ Item	D [mm]
DG 07	7
DG 09	9
DG 11	11
DG 13	13

Max. Bohrdurchmesser für Gewindeinsätze (DU)  
For DU drilling unit



## KLEMLASCHE - BUSBAR CLAMPS

Typ Item	A x B [mm]	C x D [mm]	Ø - M	Schrauben Screws	Nm
BC 25	25x20	45x40	6,5-M6	M6X35	8 Nm
BC 22	20x20	40x40	6,5-M6	M6X35	8 Nm
BC 32	32x32	52x52	6,5-M6	M6X35	8 Nm
BC 42	40x20	60x40	6,5-M6	M6X35	8 Nm
BC 43	40x32	60x52	6,5-M6	M6X35	8 Nm
BC 44	40x40	60x60	6,5-M6	M6X35	8 Nm
BC 52	50x20	75x45	8,5-M8	M8x35	20 Nm
BC 54	50x40	75x65	8,5-M8	M8x35	20 Nm
BC 55	50x50	75x75	8,5-M8	M8x35	20 Nm
BC 63	63x32	88x57	8,5-M8	M8x35	20 Nm
BC 64	63x40	88x65	8,5-M8	M8x35	20 Nm
BC 66	63x63	88x88	8,5-M8	M8x35	20 Nm
BC 84	80x40	115x75	10,5-M10	M10x35	40 Nm
BC 88	80x80	115x115	10,5-M10	M10x35	40 Nm
BC 104	100x40	135x75	10,5-M10	M10x35	40 Nm
BC 106	100x63	135x98	10,5-M10	M10x35	40 Nm
BC 110	100x100	135x135	10,5-M10	M10x35	40 Nm

Maximale Klemmstärke: 20 mm  
Max tightening thickness with supplied screws: 20 mm

Verzinkte Schrauben Klasse 8.8 / Zinc plated class 8.8 steel screws  
Piastra in acciaio zincato / Zinc plated steel plates

1 Stk verzinkte Platte 5mm mit Löchern, 1 Stk 6 mm mit Gewinde  
One 5 mm thick plate with through holes, one 6 mm thick plate with threaded holes

Sonderausführungen auf Anfrage / Special dimensions and design upon request

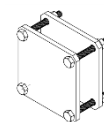
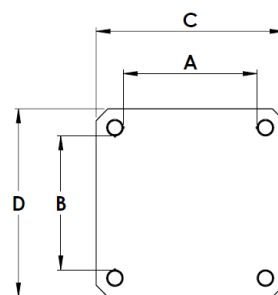
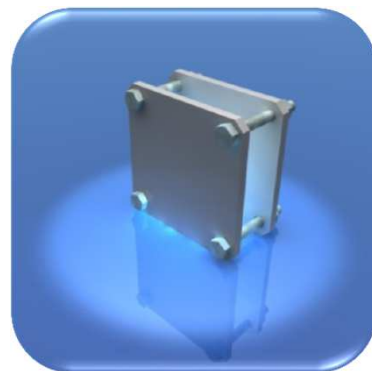

## BI-METALLPLATTEN BIMETALLIC PLATES

Gelocht Drilled	Bohrbild Holes	A [mm]	B [mm]	S [mm]	Ungebohrt Undrilled
DB 30	D1	30	30	1	UB 30
DB 40	D1	40	40	1	UB 40
DB 50	D1	50	50	1	UB 50
DB 60	D1	60	60	1	UB 60
DB 80	D4	80	80	1	UB 80
DB 100	D5	100	100	1	UB 100
DB 120	D7	120	120	1	UB 120

Cu-ETP / Al 99,5 Bi-Metallplatten mit Ø13mm Löchern  
Cu-ETP/Al 99,5 bimetallic plates - Ø13 mm holes

Sonderausführungen und Abmessungen auf Anfrage Special  
dimensions and design upon request

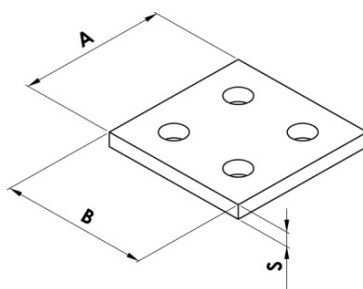

## VERZINNT KUPFERPLATTEN TIN-PLATED COPPER PLATES

Gelocht Drilled	Bohrbild Holes	A [mm]	B [mm]	S [mm]	Ungebohrt Undrilled
DP 30	D1	30	30	5	UP 30
DP 40	D1	40	40	5	UP 40
DP 50	D1	50	50	5	UP 50
DP 60	D1	60	60	5	UP 60
DP 80	D4	80	80	5	UP 80
DP 100	D5	100	100	5	UP 100
DP 120	D7	120	120	5	UP 120

Cu-ETP Platten mit Ø13mm Löchern  
Cu-ETP tin-plated plates - Ø13 mm holes

Sonderausführungen und Abmessungen auf Anfrage  
Special dimensions and design upon request

# KUPFERSCHIENEN COPPER BUSBARS

- Kupferschienen Cu-ETP UNI EN 13601  
*Cu-ETP UNI EN 13601 copper busbars*
- Verzinkt, versilbert und vernickelte Ausführung auf Anfrage  
*Tin-plated, silver-plated and nickel-plated upon request*
- Rundgewalzte / abgerundete Kanten R=1 mm  
*Flat copper bars – 1 mm radius edge*
- Sonderausführungen auf Anfrage  
*Special lengths and dimensions upon request*

Typ Item	HxS [mm]	L [mm]	Querschnitt Cross-Sect. [mm <sup>2</sup> ]	Strombelastung bei parallelen Leitern Current Load referred to no. of bars in parallel							
				ΔT 30° C [A]				ΔT 50° C [A]			
				1	2	3	4	1	2	3	4
SB 12-4	12x4	2000	48	160	292	403	451	212	387	534	598
SB 25-4	25x4	2000	100	274	500	690	772	363	663	914	1023
SB 15-5	15x5	2000	75	218	405	567	635	289	537	751	841
SB 20-5	20x5	2000	100	274	500	690	772	363	663	914	1023
SB 25-5	25x5	2000	125	327	586	795	890	433	776	1053	1179
SB 30-5	30x5	2000	150	379	672	896	1003	502	890	1187	1329
SB 40-5	40x5	2000	200	482	836	1090	1220	639	1108	1444	1617
SB 50-5	50x5	2000	250	583	994	1260	1411	772	1317	1670	1870
SB 60-5	60x5	2000	300	688	1150	1440	1613	912	1524	1908	2137
SB 80-5	80x5	2000	400	885	1450	1750	1960	1173	1921	2319	2597
SB 100-5	100x5	2000	500	1080	1730	2050	2296	1431	2292	2716	3042
SB 125-5	125x5	2000	625	1300	2022	2381	2666	1723	2679	3155	3532
SB 30-10	30x10	2000	300	573	986	1289	1547	756	1300	1701	2041
SB 40-10	40x10	2000	400	715	1230	1609	1931	944	1624	2124	2549
SB 50-10	50x10	2000	500	852	1510	2040	2448	1129	2001	2703	3243
SB 60-10	60x10	2000	600	985	1720	2300	2760	1305	2279	3048	3658
SB 80-10	80x10	2000	800	1240	2110	2790	3124	1643	2796	3697	4140
SB 100-10	100x10	2000	1000	1490	2480	3260	3651	1974	3286	4320	4838
SB 120-10	120x10	2000	1200	1740	2860	3740	4188	2306	3790	4956	5550
SB 160-10	160x10	2000	1600	2220	3590	4680	2942	4757	6201	=	=
SB 200-10	200x10	2000	2000	2690	4310	5610	3564	5711	7433	=	=

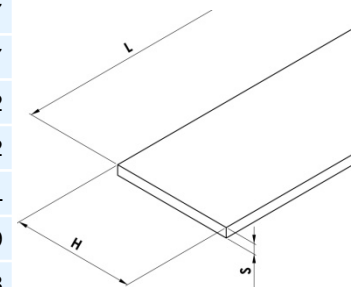

Strombelastungen sind circa Angaben (siehe Seite 28) / Conductors current loads are approximated (please see page 28)  
Verwies auf Umgebungstemperatur 35° C / Referred to Ambient Temperature 35° C (DIN 43671)

## FABRIKFERTIGE KUPFERBÄNDER PREFABRICATED COPPER BUSBAR CONNECTIONS

Sonderausführungen nach Kundenanforderung, Muster und Zeichnung auf Anfrage.  
*We can also realize special copper busbar conductors according to customers' requirements.*



## ISOLIERTE SCHIENENTRÄGER BUSBAR SUPPORTS - BUSBAR SPACERS

Gefräste Sammelschienenhalter und Abstandshalter aus unterschiedlichen Materialien oder Polyester GPO3 nach Kundenanforderung.  
*Busbar supports and spacers made by poliester GPO3 or different raw materials according to customers' requirements.*

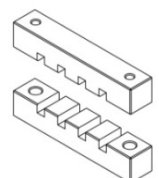

# KUPFERSCHIENEN

## COPPER BUSBARS

- Kupferschienen Cu-ETP UNI EN 13601  
*Cu-ETP UNI EN 13601 copper busbars*
- Rundgewalzte / abgerundete Kanten R=1 mm  
*Flat copper bars – 1 mm radius edge*
- Verzinkt, versilbert und vernickelte Ausführung auf Anfrage  
*Tin-plated, silver-plated and nickel-plated upon request*
- Sonderausführungen auf Anfrage  
*Special lengths and dimensions upon request*

### SCHIENEN GELOCHT

#### PERFORATED BARS

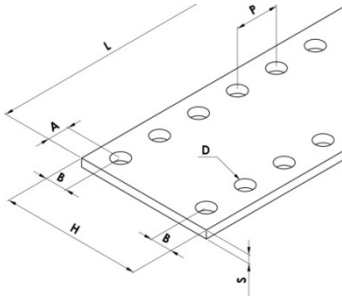

Typ Item	HxS [mm]	D [mm]	P [mm]	A - B [mm]	L [mm]	Querschnitt Cross-Sect. [mm <sup>2</sup> ]	Strombelastung bei parallelen Leitern Current Load referred to no. of bars in parallel							
							ΔT 30° C [A]				ΔT 50° C [A]			
							1	2	3	4	1	2	3	4
PB 25-5	25x5	10,5	25	12,5	1750	125	327	586	795	890	433	776	1053	1179
PB 50-5	50x5	10,5	25	12,5	1750	250	583	940	1260	1411	772	1317	1669	1870
PB 60-5	60x5	10,5	25	12,5	1750	300	718	1197	1494	1673	951	1586	1980	2217
PB 80-5	80x5	10,5	25	12,5	1750	400	885	1450	1750	1960	1173	1921	2319	2597
PB 100-5	100x5	10,5	25	12,5	1750	500	1080	1730	2050	2296	1431	2292	2716	3042
PB 125-5	125x5	10,5	25	12,5	1750	625	1300	2022	2380	2666	1722	2679	3153	3532
PB 50-10	50x10	10,5	25	12,5	1750	500	792	1404	1897	=	1050	1861	2514	=
PB 60-10	60x10	10,5	25	12,5	1750	600	916	1600	2139	=	1214	2119	2834	=
PB 80-10	80x10	10,5	25	12,5	1750	800	1153	1962	2595	=	1528	2600	3438	=
PB 100-10	100x10	10,5	25	12,5	1750	1000	1386	2306	3032	=	1836	3056	4017	=
PB 120-10	120x10	10,5	25	12,5	1750	1200	1618	2660	3478	=	2144	3524	4609	=

### SCHIENEN MIT GEWINDE LOCH

#### THREADED BARS

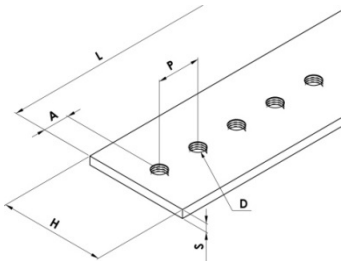

Typ Item	HxS [mm]	D [mm]	P [mm]	A [mm]	L [mm]	Querschnitt Cross-Sect. [mm <sup>2</sup> ]	Strombelastung Current load [A]	
							ΔT 30° C	ΔT 50° C
TB 12-2/1	12x2	M5	18	14	1000	24	106	142
TB 12-4/1	12x4	M5	18	14	1000	48	160	210
TB 12-5/1	12x5	M5	18	14	1000	60	182	240
TB 15-4/1	15x4	M6	20	10	1000	60	188	248
TB 15-5/1	15x5	M6	25	10	1000	75	216	286
TB 20-4/1	20x4	M6	20	10	1000	80	230	304
TB 20-5/1	20x5	M6	25	12,5	1000	100	274	362
TB 25-4/1	25x4	M6	20	10	1000	100	288	380
TB 30-5/1	30x5	M6	25	12,5	1000	150	378	502
TB 32-5/1	32x5	M6	25	12,5	1000	160	400	530
TB 30-10/1	30x10	M8	25	12,5	1000	300	572	754
TB 12-2/2	12x2	M5	18	14	2000	24	106	142
TB 12-4/2	12x4	M5	18	10	2000	48	160	210
TB 12-5/2	12x5	M5	18	14	2000	60	182	240
TB 15-4/2	15x4	M6	20	10	2000	60	188	248
TB 15-5/2	15x5	M6	25	10	2000	75	216	286
TB 20-4/2	20x4	M6	20	10	2000	80	230	304
TB 20-5/2	20x5	M6	25	12,5	2000	100	274	362
TB 25-4/2	25x4	M6	20	10	2000	100	288	380
TB 30-5/2	30x5	M6	25	12,5	2000	150	378	502
TB 32-5/2	32x5	M6	25	12,5	2000	160	400	530
TB 30-10/2	30x10	M8	25	12,5	2000	300	572	754

Strombelastungen sind circa Angaben (siehe Seite 28) / Conductors current loads are approximated (please see page 28)  
Verwies auf Umgebungstemperatur 35° C / Referred to Ambient Temperature 35° C (DIN 43671)



## SONDERANFERDIGUNGEN SPECIAL PRODUCTS

Seit vielen Jahren stellen wir neben unserem umfangreichen Angebot von Standardprodukten verschiedenste Produkte nach Kundenanforderung her.

*From many years, besides our wide range of standard products we develop and manufacture the most different types of special electrical conductors with our customers.*

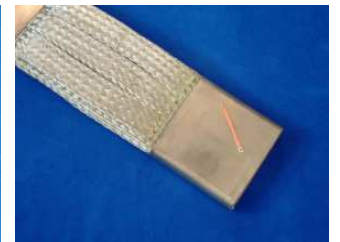
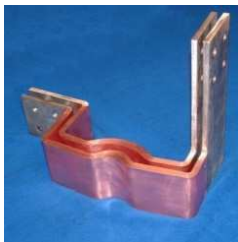
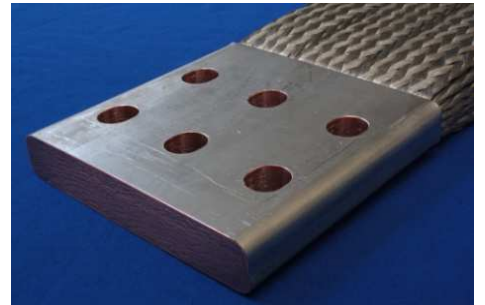
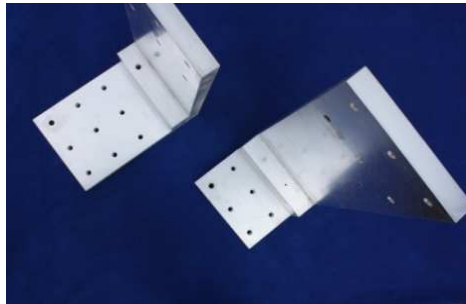
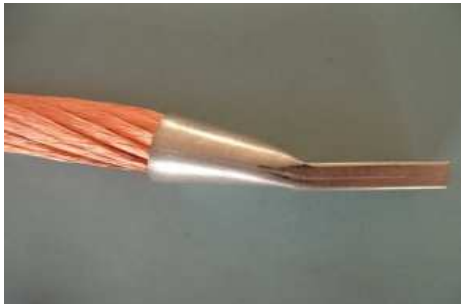

# ISOLATOREN

## SPACING INSULATORS

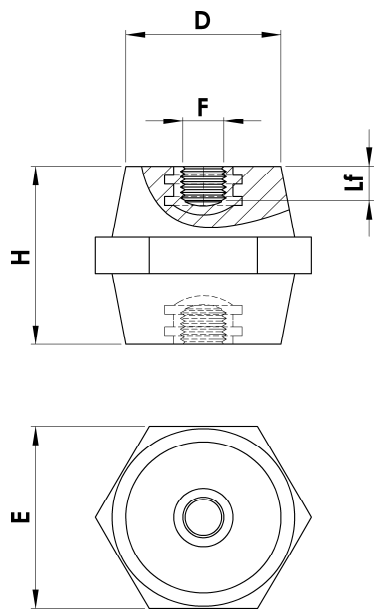

Typ Item	Abmessung Dimensions					Mechanische Eigenschaften Mechanical Data					Elektrische Eigenschaften Electrical Data			NVP Packing [pcs]
	H	E	F	D	Lf	Flex	Tors	Comp	Trax	Tn	Sci	Tnn		
12 M3-8	12	ESA 8	M 3	8	4	20	-	100	30	220	8	3	100	
15 M4-12	15	OTT 14	M 4	12	5	50	0,4	500	100	250	8	3	100	
16 M4-12	16	OTT 14	M 4	12	5	50	0,4	500	100	250	8	3	100	
20 M4-15	20	ESA 17	M 4	15	5,5	60	0,4	600	150	600	15	5	100	
20 M5-15	20	ESA 17	M 5	15	5,5	60	0,4	600	150	600	15	5	100	
20 M6-15	20	ESA 17	M 6	15	5,5	60	0,4	600	150	600	15	5	100	
25 M4-15	25	ESA 19	M 4	15	8	170	3	2300	400	600	20	7	100	
25 M5-15	25	ESA 19	M 5	15	8	170	3	2300	400	600	20	7	100	
25 M6-15	25	ESA 19	M 6	15	8	170	3	2300	400	600	20	7	100	
30 M6-26	30	ESA 30	M 6	26	9	250	3	4900	600	750	25	8	50	
30 M8-26	30	ESA 30	M 8	26	9	250	3	4900	600	750	25	8	50	
35 M6-28	35	ESA 32	M 6	28	10,5	450	5	6800	850	1000	30	10	50	
35 M8-28	35	ESA 32	M 8	28	10,5	450	5	6800	850	1000	30	10	50	
35 M10-28	35	ESA 32	M 10	28	10,5	450	5	6800	850	1000	30	10	50	
35 M6-33	35	OTT 41	M 6	33	10,5	800	10	8300	1100	1000	40	10	50	
35 M8-33	35	OTT 41	M 8	33	10,5	800	10	8300	1100	1000	40	10	50	
35 M10-33	35	OTT 41	M 10	33	10,5	800	10	8300	1100	1000	40	10	50	
36 M6-33	36	ESA 41	M 6	33	10,5	800	10	8300	1100	1000	40	10	50	
36 M8-33	36	ESA 41	M 8	33	10,5	800	10	8300	1100	1000	40	10	50	
36 M10-33	36	ESA 41	M 10	33	10,5	800	10	8300	1100	1000	40	10	50	
36 M12-33	36	ESA 41	M 12	33	10,5	800	10	8300	1100	1000	40	10	50	
40 M6-28	40	ESA 32	M 6	28	10,5	750	-	8300	1300	1000	40	10	50	
40 M8-28	40	ESA 32	M 8	28	10,5	750	-	8300	1300	1000	40	10	50	
40 M10-28	40	ESA 32	M 10	28	10,5	750	-	8300	1300	1000	40	10	50	
40 M12-28	40	ESA 32	M 12	28	10,5	750	-	8300	1300	1000	40	10	50	
41 M6-40	41	ESA 47	M 6	40	10,5	800	10	8300	1100	1000	40	10	25	
41 M8-40	41	ESA 47	M 8	40	10,5	800	10	8300	1100	1000	40	10	25	
41 M10-40	41	ESA 47	M 10	40	10,5	800	10	8300	1100	1000	40	10	25	
41 M12-40	41	ESA 47	M 12	40	10,5	800	10	8300	1100	1000	40	10	25	
45 M6-33	45	OTT 41	M 6	33	15	800	10	9800	1300	1000	40	12	25	
45 M8-33	45	OTT 41	M 8	33	15	800	10	9800	1300	1000	40	12	25	
45 M10-33	45	OTT 41	M 10	33	15	800	10	9800	1300	1000	40	12	25	
46 M8-41	46	OTT 50	M 8	41	15	800	10	9800	1300	1000	40	12	25	
46 M10-41	46	OTT 50	M 10	41	15	800	10	9800	1300	1000	40	12	25	
46 M12-41	46	OTT 50	M 12	41	15	800	10	9800	1300	1000	40	12	25	
46 M6-40	46	ESA 46	M 6	40	15	800	10	9800	1300	1000	40	12	25	
46 M8-40	46	ESA 46	M 8	40	15	800	10	9800	1300	1000	40	12	25	
46 M10-40	46	ESA 46	M 10	40	15	800	10	9800	1300	1000	40	12	25	
46 M12-40	46	ESA 46	M 12	40	15	800	10	9800	1300	1000	40	12	25	
50 M6-29	50	ESA 36	M 6	29	15	450	5	6800	850	1500	40	15	25	
50 M8-29	50	ESA 36	M 8	29	15	450	5	6800	850	1500	40	15	25	
50 M10-29	50	ESA 36	M 10	29	15	450	5	6800	850	1500	40	15	25	
50 M12-29	50	ESA 36	M 12	29	15	450	5	6800	850	1500	40	15	25	
51 M6-42	51	ESA 50	M 6	42	15	800	10	9800	1300	1500	40	12	25	
51 M8-42	51	ESA 50	M 8	42	15	800	10	9800	1300	1500	40	12	25	
51 M10-42	51	ESA 50	M 10	42	15	800	10	9800	1300	1500	40	12	25	
51 M12-42	51	ESA 50	M 12	42	15	800	10	9800	1300	1500	40	12	25	
55 M6-45	55	ESA 55	M 6	45	15	800	10	11700	1500	2000	40	15	10	
55 M8-45	55	ESA 55	M 8	45	15	800	10	11700	1500	2000	40	15	10	
55 M10-45	55	ESA 55	M 10	45	15	800	10	11700	1500	2000	40	15	10	
55 M12-45	55	ESA 55	M 12	45	15	800	10	11700	1500	2000	40	15	10	
60 M8-42	60	OTT 54	M 8	42	15	800	10	11700	1500	2000	50	15	10	
60 M10-42	60	OTT 54	M 10	42	15	800	10	11700	1500	2000	50	15	10	
60 M12-42	60	OTT 54	M 12	42	15	800	10	11700	1500	2000	50	15	10	
63 M8-32	63	ESA 41	M 8	32	15	550	5	8300	950	2000	50	20	10	
63 M10-32	63	ESA 41	M 10	32	15	550	5	8300	950	2000	50	20	10	
63 M12-32	63	ESA 41	M 12	32	15	550	5	8300	950	2000	50	20	10	
75 M8-35	75	ESA 50	M 8	35	15	900	10	12300	2350	3600	50	25	10	
75 M10-35	75	ESA 50	M 10	35	15	900	10	12300	2350	3600	50	25	10	
75 M12-35	75	ESA 50	M 12	35	15	900	10	12300	2350	3600	50	25	10	
75 M16-35	75	ESA 50	M 16	35	15	900	10	12300	2350	3600	50	25	10	
100 M8-49	100	ESA 65	M 8	49	30	1550	14	16700	2950	3600	50	30	10	
100 M10-49	100	ESA 65	M 10	49	30	1550	14	16700	2950	3600	50	30	10	
100 M12-49	100	ESA 65	M 12	49	30	1550	14	16700	2950	3600	50	30	10	
100 M16-49	100	ESA 65	M 16	49	30	1550	14	16700	2950	3600	50	30	10	

Poliamide 6 - 30% verstärkt  
 Polyamide 6 - reinforced 30%  
 Inlett F/F verzinkter Stahl  
 Inserts F/F in zinc plated steel  
 Farbe rot RAL 3003

Colour Red RAL 3003  
 Selbstverlöschend UL 94 V0  
 Self-extinguishing UL 94 V0  
 Temperaturbereich: -40°C to +120°C  
 Working temperature: -40°C to +120°C  
 Dielektrische Konstante (ASTM D150): 4/5  
 Dielectric constant (ASTM D150): 4/5  
 Lichtbogenbeständigkeit (ASTM D495): sec>180  
 Arc resistance (ASTM D495): sec>180  
 Wasser abweisend (ASTM D570) <1,2%  
 Water absorption (ASTM D570) <1,2%

# ABSTANDSSÄULEN SPACING COLUMNS



Typ Item	Abmessung Dimensions				[mm]	Mechanische Eigenschaften Mechanical Data				Elektrische Eigenschaften Electrical Data			NVP Packing [pcs]
	H	E	F	D		Lf	Flex	Tors	Comp	Trax	Tn	Sci	
C16 M4-20	16	ESA 21	M 4	20	3,9	250	-	400	400	400	10	3	100
C16 M5-20	16	ESA 21	M 5	20	3,9	250	-	400	400	400	10	3	100
C16 M6-20	16	ESA 21	M 6	20	3,9	250	-	400	400	400	10	3	100
C20 M4-20	20	ESA 21	M 4	20	5	250	-	600	400	600	10	4	100
C20 M5-20	20	ESA 21	M 5	20	5	250	-	600	400	600	10	4	100
C20 M6-20	20	ESA 21	M 6	20	5	250	-	600	400	600	10	4	100
C25 M5-20	25	ESA 21	M 5	20	8	200	5	600	400	600	15	5	100
C25 M6-20	25	ESA 21	M 6	20	8	200	5	600	400	600	15	5	100
C25 M8-20	25	ESA 21	M 8	20	8	200	5	600	400	600	15	5	100
C30 M5-20	30	ESA 21	M 5	20	9	200	5	600	400	600	15	5	50
C30 M6-20	30	ESA 21	M 6	20	9	200	5	600	400	600	15	5	50
C30 M8-20	30	ESA 21	M 8	20	9	200	5	600	400	600	15	5	50
C35 M5-20	35	ESA 21	M 5	20	9	150	8	600	400	600	25	8	50
C35 M6-20	35	ESA 21	M 6	20	9	150	8	600	400	600	25	8	50
C35 M8-20	35	ESA 21	M 8	20	9	150	8	600	400	600	25	8	50
C40 M5-20	40	ESA 21	M 5	20	9	150	8	600	400	600	25	8	50
C40 M6-20	40	ESA 21	M 6	20	9	150	8	600	400	600	25	8	50
C40 M8-20	40	ESA 21	M 8	20	9	150	8	600	400	600	25	8	50
C45 M5-20	45	ESA 21	M 5	20	9	150	8	600	400	600	25	8	50
C45 M6-20	45	ESA 21	M 6	20	9	150	8	600	400	600	25	8	50
C45 M8-20	45	ESA 21	M 8	20	9	150	8	600	400	600	25	8	50
C50 M5-20	50	ESA 21	M 5	20	9	100	10	750	400	750	30	10	50
C50 M6-20	50	ESA 21	M 6	20	9	100	10	750	400	750	30	10	50
C50 M8-20	50	ESA 21	M 8	20	9	100	10	750	400	750	30	10	50
C30 M6-30	30	ESA 30	M 6	30	9	450	8	750	900	750	25	8	50
C30 M8-30	30	ESA 30	M 8	30	9	450	8	750	900	750	25	8	50
C30 M10-30	30	ESA 30	M 10	30	9	450	8	750	900	750	25	8	50
C35 M6-30	35	ESA 30	M 6	30	10,5	450	8	750	900	750	25	8	50
C35 M8-30	35	ESA 30	M 8	30	10,5	450	8	750	900	750	25	8	50
C35 M10-30	35	ESA 30	M 10	30	10,5	450	8	750	900	750	25	8	50
C40 M6-30	40	ESA 30	M 6	30	10,5	300	10	1.000	900	1.000	30	10	25
C40 M8-30	40	ESA 30	M 8	30	10,5	300	10	1.000	900	1.000	30	10	25
C40 M10-30	40	ESA 30	M 10	30	10,5	300	10	1.000	900	1.000	30	10	25
C45 M6-30	45	ESA 30	M 6	30	15	300	10	1.000	900	1.000	30	10	25
C45 M8-30	45	ESA 30	M 8	30	15	300	10	1.000	900	1.000	30	10	25
C45 M10-30	45	ESA 30	M 10	30	15	300	10	1.000	900	1.000	30	10	25
C45 M12-30	45	ESA 30	M 12	30	15	300	10	1.000	900	1.000	30	10	25
C50 M6-30	50	ESA 30	M 6	30	15	200	15	1.500	900	1.500	40	10	25
C50 M8-30	50	ESA 30	M 8	30	15	200	15	1.500	900	1.500	40	10	25
C50 M10-30	50	ESA 30	M 10	30	15	200	15	1.500	900	1.500	40	10	25
C55 M6-30	55	ESA 30	M 6	30	15	200	15	1.500	900	1.500	40	10	25
C55 M8-30	55	ESA 30	M 8	30	15	200	15	1.500	900	1.500	40	10	25
C55 M10-30	55	ESA 30	M 10	30	15	200	15	1.500	900	1.500	40	10	25
C60 M6-30	60	ESA 30	M 6	30	15	150	15	1.500	900	1.500	40	15	25
C60 M8-30	60	ESA 30	M 8	30	15	150	15	1.500	900	1.500	40	15	25
C60 M10-30	60	ESA 30	M 10	30	15	150	15	1.500	900	1.500	40	15	25
C65 M6-30	65	ESA 30	M 6	30	15	150	15	1.500	900	1.500	40	15	25
C65 M8-30	65	ESA 30	M 8	30	15	150	15	1.500	900	1.500	40	15	25
C65 M10-30	65	ESA 30	M 10	30	15	150	15	1.500	900	1.500	40	15	25
C70 M6-30	70	ESA 30	M 6	30	15	150	15	1.500	900	1.500	40	15	25
C70 M8-30	70	ESA 30	M 8	30	15	150	15	1.500	900	1.500	40	15	25
C70 M10-30	70	ESA 30	M 10	30	15	150	15	1.500	900	1.500	40	15	25
C45 M8-40	45	ESA 41	M 8	40	15	500	10	1.000	1.000	1.000	30	10	20
C45 M10-40	45	ESA 41	M 10	40	15	500	10	1.000	1.000	1.000	30	10	20
C50 M8-40	50	ESA 41	M 8	40	15	500	10	1.500	1.000	1.500	40	10	20
C50 M10-40	50	ESA 41	M 10	40	15	500	10	1.500	1.000	1.500	40	10	20
C50 M12-40	50	ESA 41	M 12	40	15	500	10	1.500	1.000	1.500	40	10	20
C55 M8-40	55	ESA 41	M 8	40	15	500	10	1.500	1.000	1.500	40	10	20
C55 M10-40	55	ESA 41	M 10	40	15	500	10	1.500	1.000	1.500	40	10	20
C55 M12-40	55	ESA 41	M 12	40	15	500	10	1.500	1.000	1.500	40	10	20
C60 M8-40	60	ESA 41	M 8	40	15	370	15	1.500	1.000	1.500	40	15	20
C60 M10-40	60	ESA 41	M 10	40	15	370	15	1.500	1.000	1.500	40	15	20
C60 M12-40	60	ESA 41	M 12	40	15	370	15	1.500	1.000	1.500	40	15	20
C65 M8-40	65	ESA 41	M 8	40	15	370	15	1.500	1.000	1.500	40	15	15
C65 M10-40	65	ESA 41	M 10	40	15	370	15	1.500	1.000	1.500	40	15	15
C65 M12-40	65	ESA 41	M 12	40	15	370	15	1.500	1.000	1.500	40	15	15
C70 M8-40	70	ESA 41	M 8	40	15	370	15	1.500	1.000	1.500	40	15	15
C70 M10-40	70	ESA 41	M 10	40	15	370	15	1.500	1.000	1.500	40	15	15
C70 M12-40	70	ESA 41	M 12	40	15	370	15	1.500	1.000	1.500	40	15	15

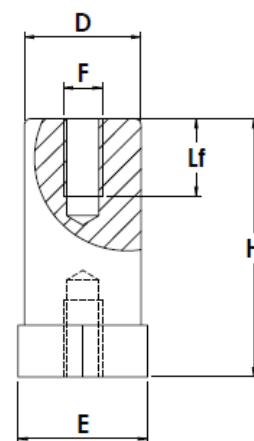

Mechanische Eigenschaften  
Mechanical Data

- Flex Biegestärke  
*bending strength*
- Tors Verdrehverformung  
*torsional strength*
- Comp Stauchungskraft  
*compression strength*
- Trax Verdrehkraft  
*tensile strength*

Angaben in daN - 1 daN = 1Kg  
Values in daN - 1 daN = 1Kg

Elektrische Eigenschaften  
Electrical Characteristics

- Tn Nennspannung  
*nominal voltage*  
[Volt - AC - DC]
- Sci Spannungsfestigkeit  
*internal discharge voltage*  
[kVolt - AC]
- Tnn Nennspannung bei 50Hz  
*nominal voltage at 50Hz*  
für 1 minute - for 1 minute [kV]

# SCHRUMPFSCHLÄUCHE

## HEAT SHRINK TUBING



### Technische Eigenschaften

### Technical Characteristics

Testbeschreibung / Test description	Getestete Ergebnisse/Recorded result	Norm / Following norm
<b>Fisiche - Physical</b>		
Vernetztes Polyolefin / Crosslinked polyolefin		
Zugbelastung / Tensile strength	12 N/mm <sup>2</sup> (min.)	ASTM D638
Max. Ausdehnung / Ultimate elongation	300% (min.)	ASTM D638
Wasserabsorption / Water absorption	0,5 % ( max. )	ASTM D570
Dichtigkeit / Density	1,2 ± 0,2 gm/cm <sup>3</sup>	ASTM D792
Mech. Festigkeit für Elastomere / Hardness	45 ± 10 shore D	ASTM D2240
<b>Wärmemessung - Thermal</b>		
Schnellalterungsversuch / Accelerate ageing (a+b)	120 °C x 500 hrs	ASTM D2671
Zugbelastung / Tensile strength (a)	10 N/mm <sup>2</sup> (min.)	ASTM D638
Zugbelastung / Ultimate elongation (b)	250% (min.)	ASTM D638
Niedrigsttemperatur max. / Low temperature flexibility (- 40° C x 4 hrs)	Keine Einrisse/No cracking	ASTM D2671
Shock termico / Heat shock (250 °C x 30 min.)	Keine Einrisse/No cracking	ESI 09-11
Schrumpftemperatur / Shrink temperature	125 °C	IEC 216
Dauereinsatztemperatur / Continuous temperature limit	- 55 °C +125 °C (GSC)	IEC 216
Dauereinsatztemperatur / Continuous temperature limit	- 40 °C +115 °C (GMB - GHB)	IEC 216
<b>Elektrische Kennwerte - Electrical</b>		
Dielektrische Durchschlagsspannung / Dielectric strength	22 kV/mm (min.)	ASTM D149
Widerstandsvermögen / Volume resistivity	1x10 <sup>14</sup> Ohm.cm (min.)	ASTM D257
Dielektrische Konstante / Dielectric constant	5 (max)	ASTM D150
Beständigkeit und Verschleiß / Resistant to track & erosion	bis zu/up to 3,25 kV x 20 (min.)	ASTM D2303



### DÜNNWANDIGER SCHRUMPFSCHLAUCH

### THIN WALL TUBE

**Isolation** bis **1,1 kV**  
**Electrical insulation** up to **1,1 kV**  
**Farbe schwarz**  
**Black color**

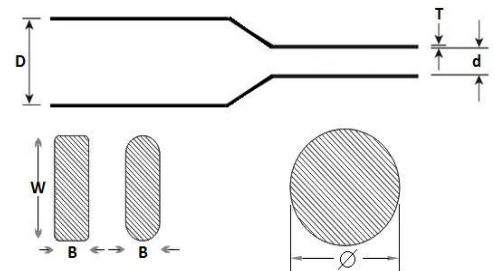

Typ Item	D min.	d max.	T ± 10%	Confez. Pack.	Flachschiene W+B		Rundstange Ø	
					Rectangular bar W+B		Round bar Ø	
					min. [mm]	max. [mm]	min. [mm]	max. [mm]
GSC 1.5/0.75	1,5	0,75	0,28	200	=	=	=	=
GSC 2.5/1.2	2,5	1,2	0,44	200	=	=	=	=
GSC 4/2	4	2	0,44	200	=	=	=	=
GSC 6/3	6	3	0,56	100	=	=	=	=
GSC 10/5	10	5	0,56	100	=	=	=	=
GSC 12.7/6.35	12,7	6,35	0,56	100	=	=	=	=
GSC 16/8	15	7,5	0,69	100	12	18	8	12
GSC 20/10	20	10	0,78	100	16	25	12	16
GSC 25/12.5	25	12,5	0,78	50	20	31	14	20
GSC 30/15	30	15	0,86	50	23	38	18	24
GSC 40/20	40	20	0,6	50	34	52	23	33
GSC 50/25	50	25	0,96	25	43	65	28	41
GSC 76/38	76	38	1,27	25	63	97	44	62
GSC 100/50	100	50	1,40	25	102	125	55	80
GCS 150/75	150	75	1,40	25	119	190	80	121

Bis zu 250 mm Durchmesser sowie andere Farben auf Anfrage erhältlich / Up to 250 mm diameters and other colors available upon request

# SCHRUMPFSCHLÄUCHE HEAT SHRINK TUBING

**Isolation**  
*Electrical insulation* **bis**  
*up to* **24 kV** **Farbe rot**  
*Red brick color*

**MITTELWANDIGER SCHRUMPFSCHLAUCH**  
***MEDIUM WALL TUBE***



Typ Item	D min.	d max. [mm]	T ± 10%	Confez. Pack. [m]	Flachschiene W+B Rectangular bar W+B		Rundstange Ø Round bar Ø	
					min. [mm]	max. [mm]	min. [mm]	max. [mm]
GMB 16/6	16	6	2,0	25	12	18	6,5	12
GMB 25/8	25	8	2,5	25	16	30	9	20
GMB 30/12	30	12	2,5	25	22	38	13,5	25
GMB 40/16	40	16	2,5	25	29	50	18	32
GMB 50/20	50	20	2,5	25	36	63	22	40
GMB 65/25	65	25	2,7	25	46	82	28	52
GMB 75/28	75	28	3,0	25	55	94	33	60
GMB 85/32	85	32	3,0	25	58	107	37	68
GMB 100/38	100	38	3,0	25	70	126	44	80
GMB 120/45	120	45	3,0	15	90	150	55	96
GMB 150/60	150	60	3,0	15	110	200	70	127
GMB 180/70	180	70	3,0	15	125	226	80	144
GMB 205/85	205	85	3,0	15	200	257	127	164
GMB 250/120	250	120	3,0	15	220	314	140	200

**Isolation**  
*Electrical insulation* **bis**  
*up to* **36 kV** **Farbe rot**  
*Red brick color*

**DICKWANDIGER SCHRUMPFSCHLAUCH**  
***HIGH WALL TUBE***



Typ Item	D min.	d max. [mm]	T ± 10%	Confez. Pack. [m]	Flachschiene W+B Rectangular bar W+B		Rundstange Ø Round bar Ø	
					min. [mm]	max. [mm]	min. [mm]	max. [mm]
GHB 25/8	25	8	3.7	25	17	28	11	20
GHB 30/12	30	12	4.0	25	21	33	15	25
GHB 40/16	40	16	4.0	25	28	45	15	32
GHB 50/20	50	20	4.0	25	34	54	24	40
GHB 65/25	65	25	4.0	25	41	62	27	43
GHB 75/28	75	28	4.0	20	47	69	28	47
GHB 85/32	85	32	4.0	20	58	100	37	68
GHB 100/38	100	38	4.2	20	69	102	44	72
GHB 120/45	120	45	4.2	15	83	125	50	85
GHB 150/60	150	60	4.5	15	102	168	65	105
GHB 180/70	180	70	4.5	15	133	196	85	125
GHB 205/85	205	85	4.5	15	200	250	127	164
GHB 250/120	250	120	4.5	15	220	314	140	200

Andere Abmessungen auf Anfrage / Other diameters available upon request

Spannung Voltage	Abstand mit Isolierung - Clearance with insulation				Abstand ohne Isolierung Clearance without insulation
	Mittelwandiger Schrumpfschlauch aus der GMB-Serie Medium wall tube GMB series		Dickwandiger Schrumpfschlauch aus der GHB-Serie Heavy wall tube GHB series		
	Phase zu Phase phase to phase	Phase zu Erdung phase to ground	Phase zu Phase phase to phase	Phase zu Erdung phase to ground	
12 kV	65 mm	75 mm	35 mm	45 mm	120 mm
17,5 kV	85 mm	105 mm	55 mm	65 mm	160 mm
24 kV	115 mm	150 mm	70 mm	100 mm	220 mm
36 kV	200 mm	285 mm	140 mm	190 mm	320 mm

## BUS TAPE

**SCHRUMPFBAND** für Mittelspannungs-Isolation  
**HEAT SHRINK TAPE** for Medium Voltage insulation

Typ Item	Breite Width	Länge Length	Dicke Thickness
GMT-2	50 mm	5,0 m	1,0 ± 0,10 mm
GMT-2L	50 mm	15,0 m	1,0 ± 0,10 mm



# TECHNISCHE INFORMATIONEN

## TECHNICAL INFORMATION

Die in den einzelnen Seiten angegebenen Belastungen bei 65 °C wie auch 105 °C basieren auf einer Umgebungstemperatur von 35 °C. Diese Werte gelten ausschließlich für nicht isolierte Ausführungen und sind Annäherungswerte. Für isolierte Anwendungen ist eine derating von etwa 20 % vorzunehmen. Bitte beachten Sie, dass die Temperatur eines Leiters auf die Materialien der Installation und Anwendungsbedingungen abzustimmen sind. Der Querschnitt eines Leiters darf bis zu 80% der festen Werte nach Norm DIN 46276 reduziert werden.

*Current loads on our data sheets are related to the temperatures of the conductor of 65 °C and 105 °C and to the ambient temperature of 35 °C. These are approximated values for non insulated connections.*

*For insulated applications please consider a reducing current load factor about 15%.*

*Please notice that the temperature of a conductor depends on the installation and the working conditions and a reducing current load factor has to be considered if necessary.*

*The cross-section of a flexible conductor cannot be reduced by over 80% of the same section of a solid bar according to DIN 46276 norm.*

### Anpassung des Strombelastungsfaktors H

#### Adjustment current load factor H

Aktuelle Lastangaben auf unseren Datenblättern kann mit Bezug auf Änderungen der Temperatur ermittelt werden. Anpassung aktuelle Auslastung  $H = 1$  bei einer Umgebungstemperatur von 35 °C und Kupfer Temperatur von 65 °C. Zum Beispiel: Bei gleicher Umgebungstemperatur von 35 °C herrscht eine Kupfer-Temperatur von 70 °C vor, so ist die aktuelle Belastung H mit dem Faktor 1,1 multipliziert.

*Current loads on our data sheets can be adjusted with reference to variations of temperature.*

*Adjustment Current load factor  $H=1$  at ambient temperature of 35 °C and copper temperature of 65 °C.*

*For example, if you allow at the same ambient temperature of 35 °C a copper temperature of 70 °C, the current load has to be multiplied for a factor  $H=1,1$ .*

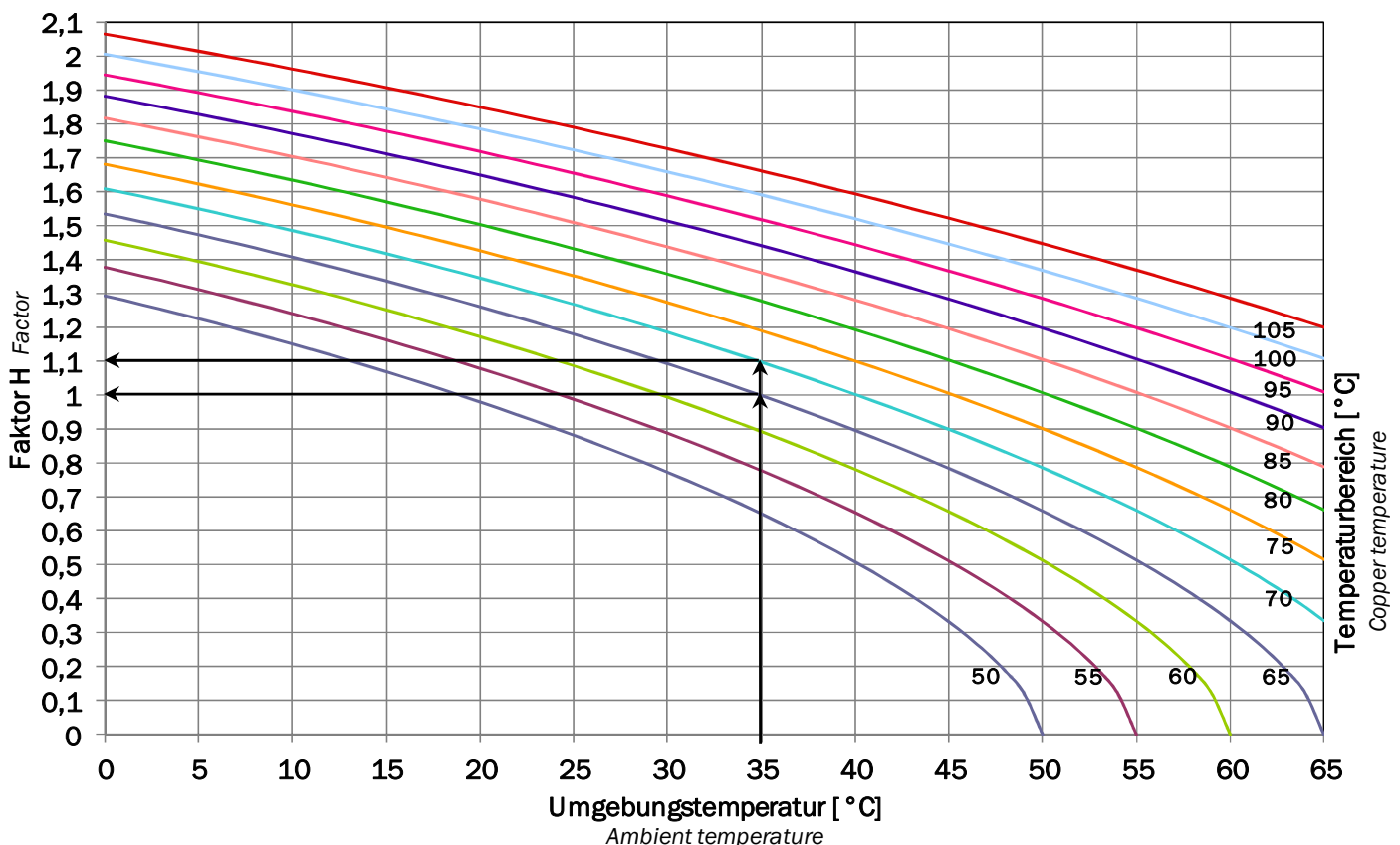

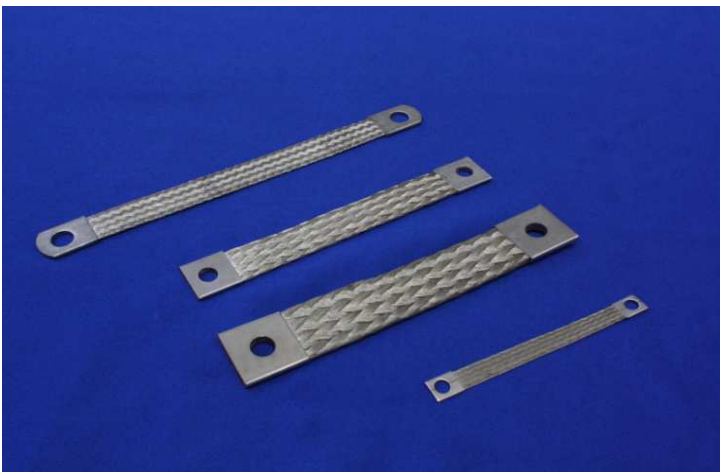
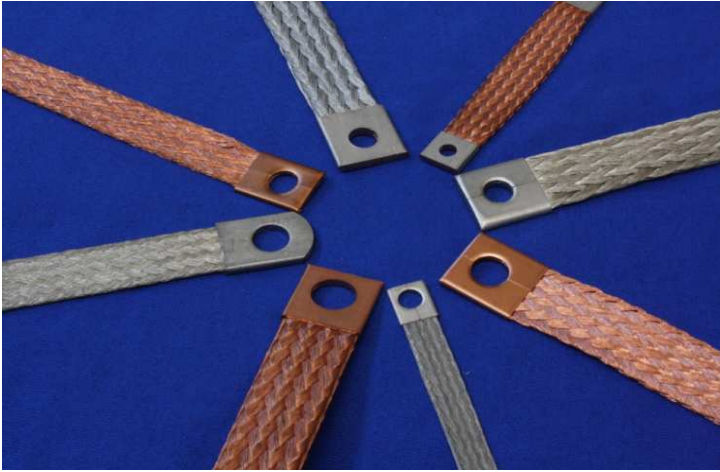

**FOTOGALERIE**  
**PHOTO GALLERY**

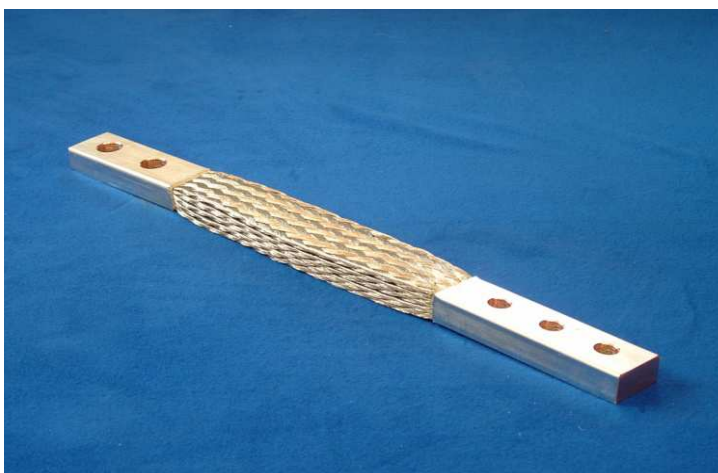
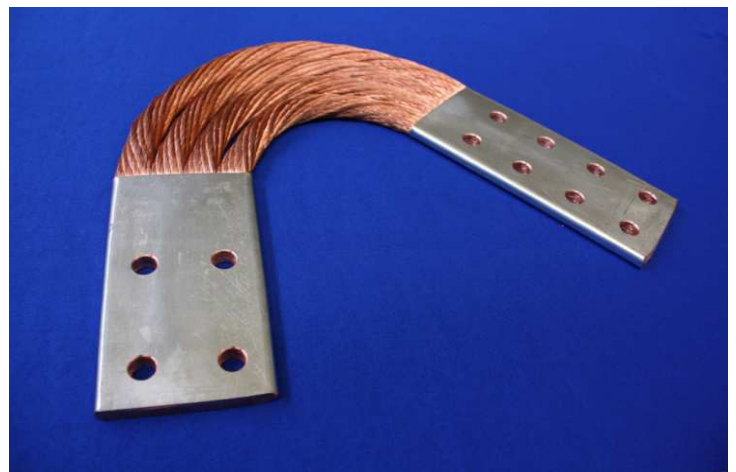
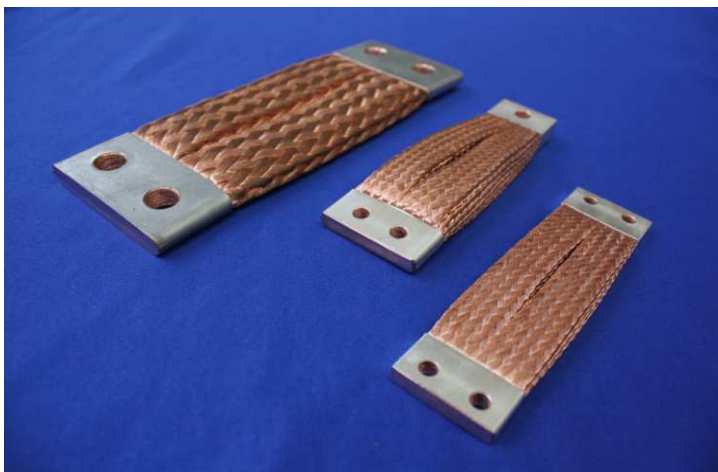
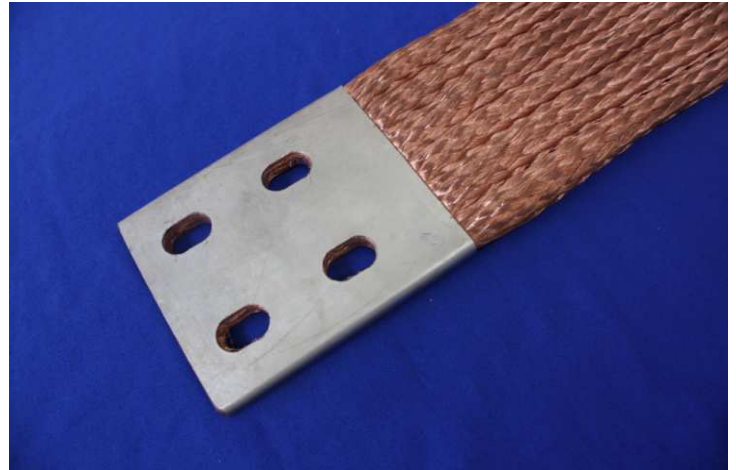



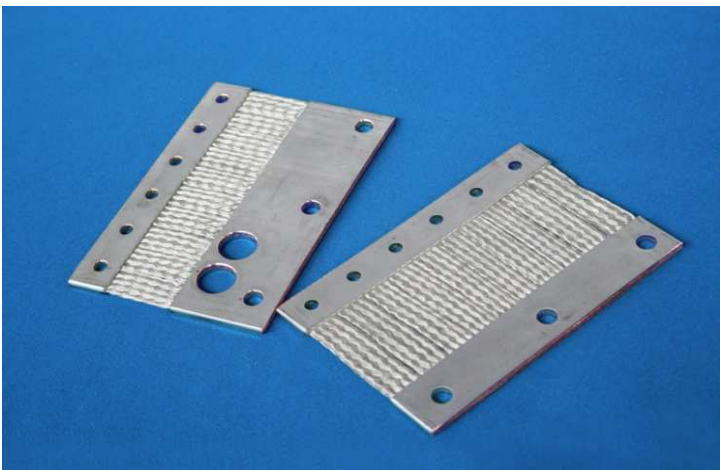

**FOTOGALERIE**  
**PHOTO GALLERY**



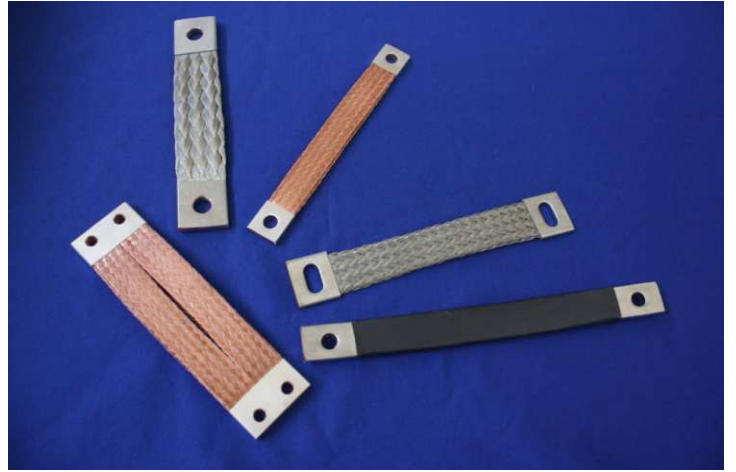

**FOTOGALERIE**  
**PHOTO GALLERY**

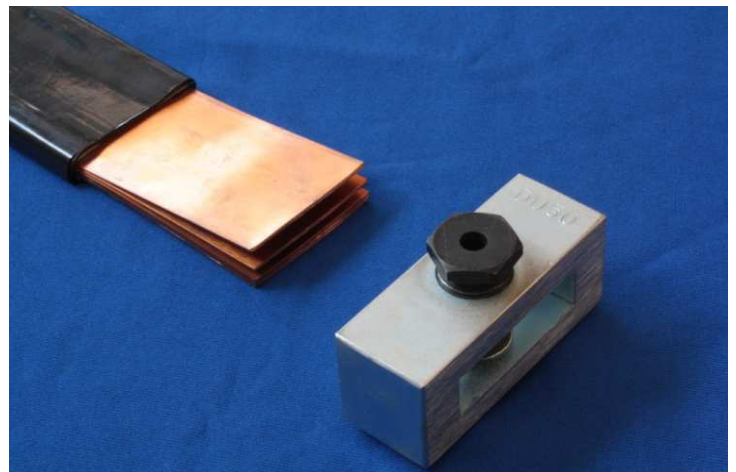
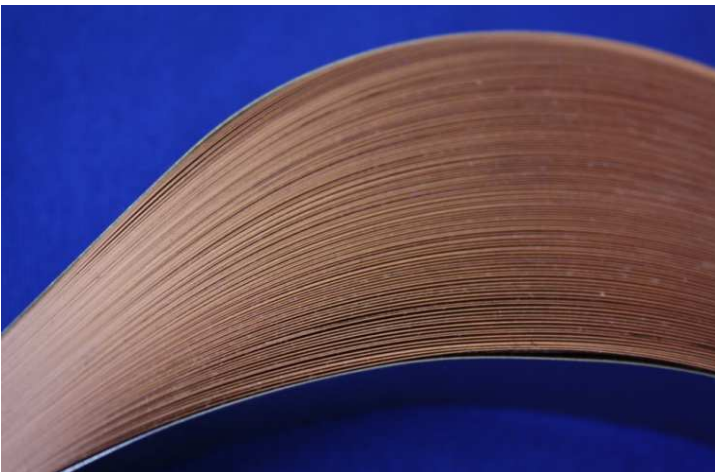
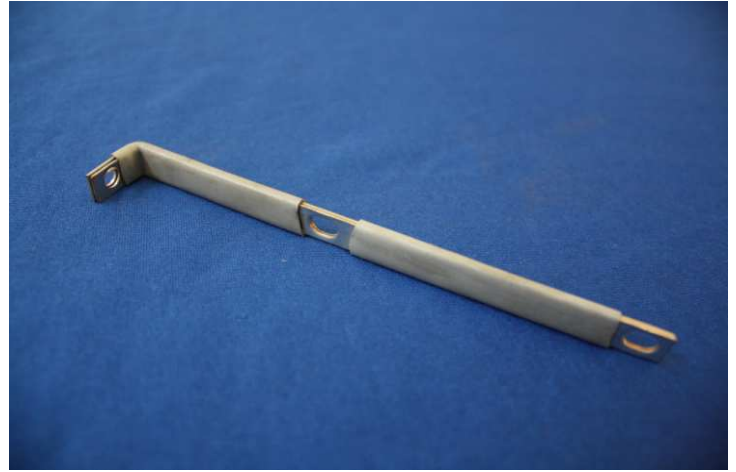

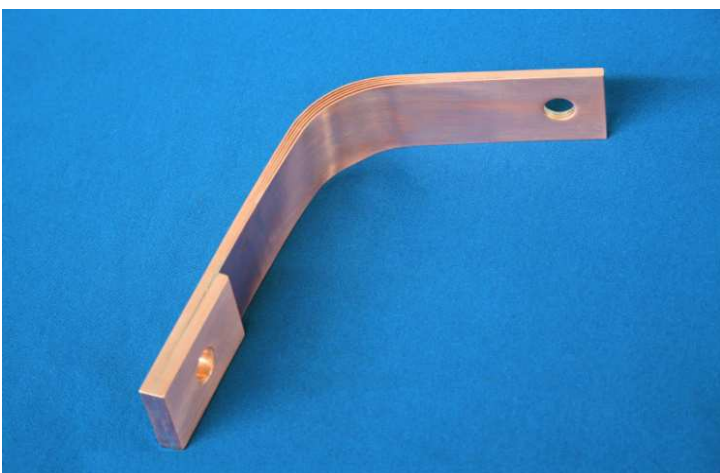
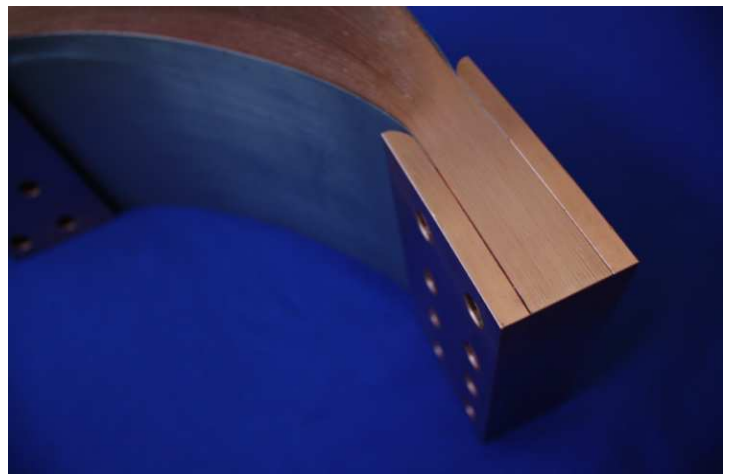
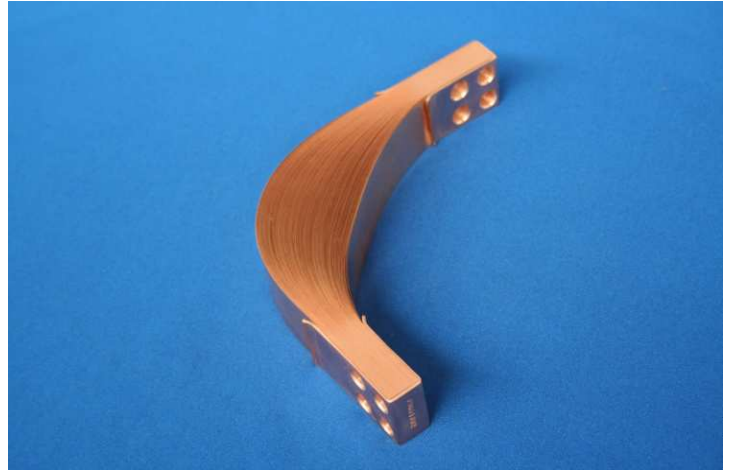
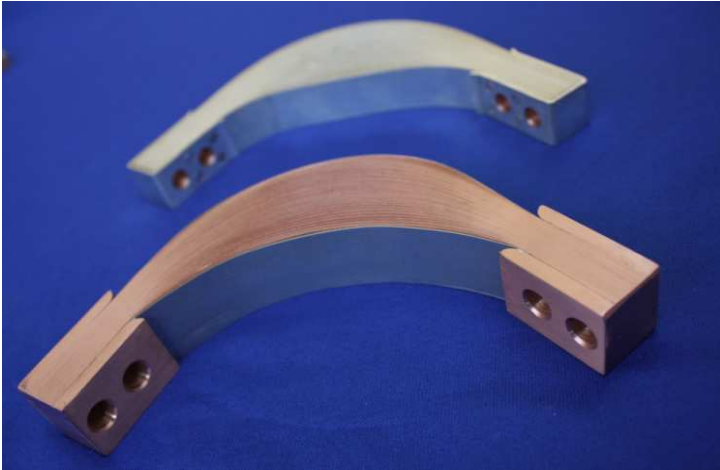

**FOTOGALERIE**  
**PHOTO GALLERY**

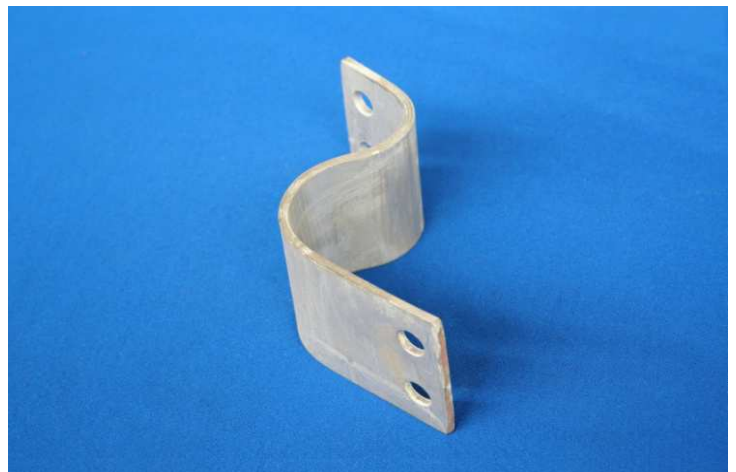
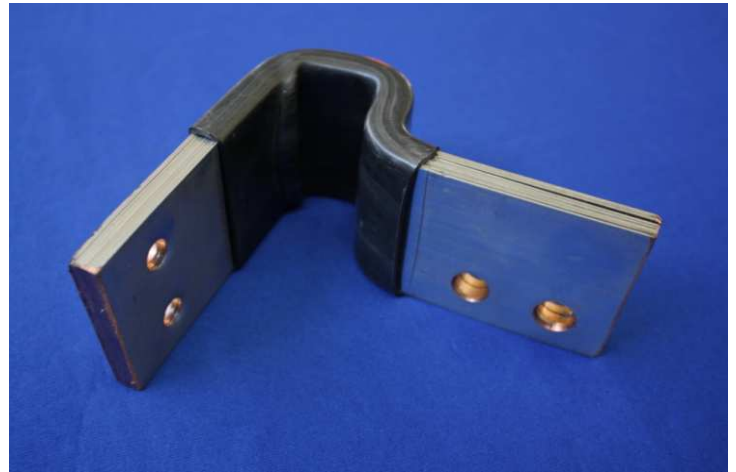
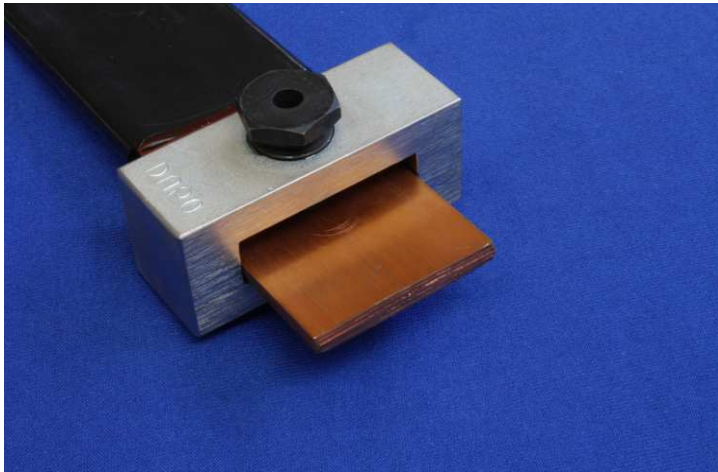

*...dedicato a nostro padre*



**55 ANNI YEARS**  
1959 - 2014

[www.brunoconductors.it](http://www.brunoconductors.it)

PRODUKTIONSBEREICH ELEKTRO-MECHANIK  
ELECTRICAL DIVISION



PRODUKTIONSBEREICH METALLBEARBEITUNG  
MECHANICAL DIVISION



**bruno**  
CONDUCTORS

  
55 ANNI YEARS  
1959-2014

F.lli BRUNO & C. Snc - Via Piosasco, 96 - 10090 Bruino - Italy  
Tel. +39 011 9048348 - Fax +39 011 9085111 e-mail: [bruno@conductors.it](mailto:bruno@conductors.it)